

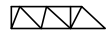



Torre/Reazioni – Masts/Reactions – Mat/Réactions – Maste/Eckdrücke – Mästil/Reacciones – Tramo/Reacções

SK1700

 50 m  $\rightarrow$  65 m

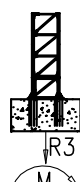
Torre/Masts/Mat/Maste/Mästil/Tramo															
TRO	H[m]	4f/4f BF117	4f/4f BF052	4f/4f BF039	4f/2f SB117	4f/2f SB052	4f/2f SB039	2f/2f ST117	2f/2f ST052	2f/2f ST039	2f/2f STB117	2f/2f STB039	2f/2f RA039	4f/2f SBB039	4f/2f SBB117
	52	1	1		1			2							
	55.9	2			1			1	1	1					
TTD	52		3			1			6						
	46.8	1			1			2							
	35.1							3							
	55.9	2			1			1	1	1					
*	59.9		4									7	1	1	
*	50.7											6	1		1

Torre/Masts/Mat/Maste/Mästil/Tramo															
CAF	H[m]	4f/4f BF117	4f/4f BF052	4f/4f BF039	4f/2f SB117	4f/2f SB052	4f/2f SB039	2f/2f ST117	2f/2f ST052	2f/2f ST039	2f/2f STB117	2f/2f STB039	2f/2f RA039	4f/2f SBB039	4f/2f SBB117
	55.8	1			1			2		1					
	50.7							4		1					
	59.8	1			1			2		2					
	40.3							3							
	57.2		3			1			6						
*	40.3											7	1	1	
*	59.8											12	1	1	
*	59.8	1										7	1		1

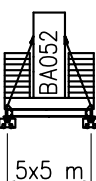
Torre/Masts/Mat/Maste/Mästil/Tramo															
CATR	H[m]	4f/4f BF117	4f/4f BF052	4f/4f BF039	4f/2f SB117	4f/2f SB052	4f/2f SB039	2f/2f ST117	2f/2f ST052	2f/2f ST039	2f/2f STB117	2f/2f STB039	2f/2f RA039	4f/2f SBB039	4f/2f SBB117
	52							4							
	52								9						
	40.3							3							
	45.5							3	1						
CATC	33.8	1	1		1										
*	52	1										5	1		1
*	52											8	1		1
*	50.7											11	1		

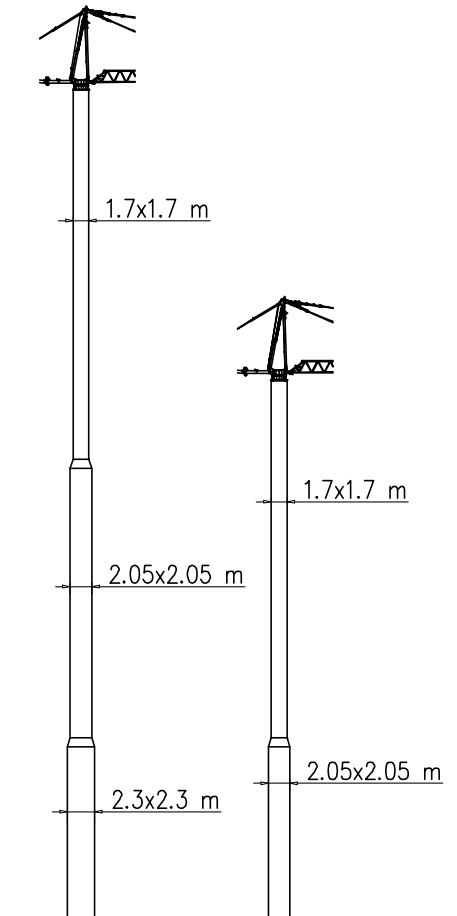

H=0-45 m		H=46-60 m	
R1	89 t	R1	106 t
R2	88 t	R2	106 t
R3	74 t	R3	95 t
M	194 tm	M	336 tm

Peso zavorra–Ballast weight–Poids du lest  
Ballastgewicht–Peso de lastre

H	Tot.
0-30 m	63600 kg
31-45 m	70600 kg
46-48 m	77600 kg
49-54 m	98600 kg
55-60 m	105600 kg

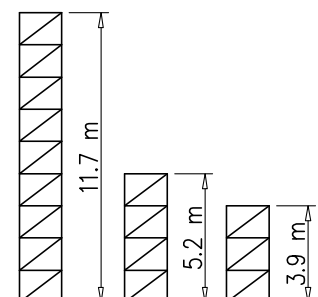

SN2050

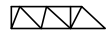
 50 m  $\rightarrow$  65 m

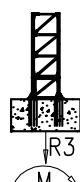
Torre/Masts/Mat/Maste/Mästil/Tramo															
	H[m]	4f/4f BF117	4f/4f BF052	4f/4f BF039	4f/2f SB117	4f/2f SB052	4f/2f SB039	2f/2f ST117	2f/2f ST052	2f/2f ST039	2f/2f STB117	2f/2f STB039	2f/2f RA039	4f/2f SBB039	4f/2f SBB117
TRO 	62.4	2			1			2		1					
	61.1	1	1		1			2	1	1					
TTD 	61.1		4			1			6	1					
	46.8							4							
	52	1	1		1			2							
	* 62.4		3									10	1	1	
	* 62.4	1										9	1		1
	* 62.4	1										11	1	1	

Torre/Masts/Mat/Maste/Mästil/Tramo															
	H[m]	4f/4f BF117	4f/4f BF052	4f/4f BF039	4f/2f SB117	4f/2f SB052	4f/2f SB039	2f/2f ST117	2f/2f ST052	2f/2f ST039	2f/2f STB117	2f/2f STB039	2f/2f RA039	4f/2f SBB039	4f/2f SBB117
CAF 	63.7	1			1			3							
	67.6	2			1			2							
	67.6		4				1		7						
	50.7		1			1		3							
	52				1			3							
	* 65		3			1						9	1		
	* 63.7	1										8	1		1
* 65.3	1				1						10	1			

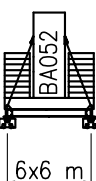
Torre/Masts/Mat/Maste/Mästil/Tramo															
	H[m]	4f/4f BF117	4f/4f BF052	4f/4f BF039	4f/2f SB117	4f/2f SB052	4f/2f SB039	2f/2f ST117	2f/2f ST052	2f/2f ST039	2f/2f STB117	2f/2f STB039	2f/2f RA039	4f/2f SBB039	4f/2f SBB117
CATR IIII CATC 	59.8	1			1			2		2					
	59.8		3			1			5	2					
	45.5					1		3							
	49.4		1				1			9					
	32.5				1			1		1					
* 59.8		3									8	1	1		
* 59.8	1										9	1	1		
* 59.8	1										7	1		1	

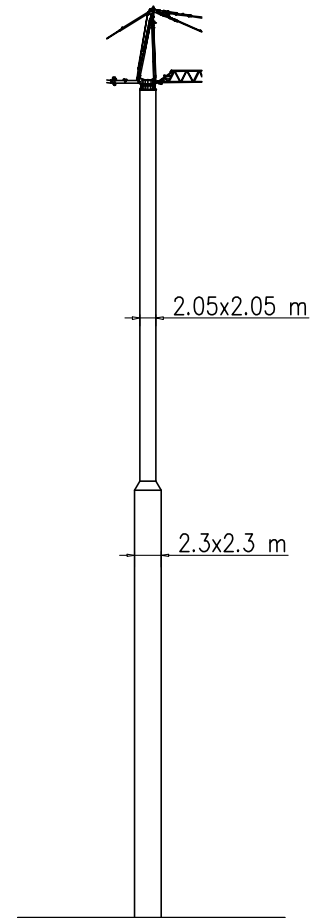

H=0-45 m		H=46-68 m	
R1	125 t	R1	140 t
R2	130 t	R2	144 t
R3	95 t	R3	103 t
M	486 tm	M	570 tm





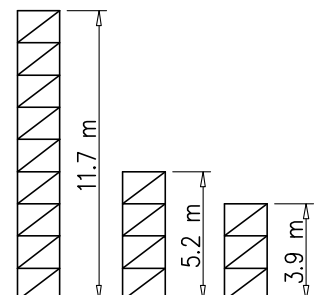

Peso zavorra-Ballast weight-Poids du lest  
Ballastgewicht-Peso de lastre

H	Tot.
0-55 m	102320 kg
56-68 m	112460 kg

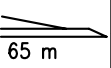

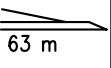

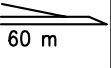

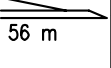

Curve di carico – Courbes de charges – Load diagrams – LastKurven – Curvas de cargas

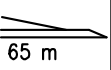

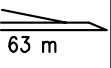

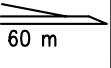

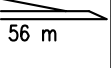
Pmax 4000 kg

	25600 kg		3.5	30	34	36	38	40	42	44	46	48	50	52	54	56	58	60	62	65	m
			4000	4000	3360	3190	2940	2770	2490	2350	2220	2110	1950	1850	1760	1650	1570	1500	1300	1000	kg
	25600 kg		3.5	30	34	36	38	40	42	44	46	48	50	52	54	56	58	60	63	m	
			4000	4000	3360	3190	2940	2770	2490	2350	2220	2110	1950	1850	1760	1650	1570	1500	1300	kg	
	25600 kg		3.5	30	34	36	38	40	42	44	46	48	50	52	54	56	58	60	m		
			4000	4000	3480	3250	3050	2860	2700	2550	2410	2280	2170	2060	1960	1870	1780	1700	kg		
	25600 kg		3.5	34	36	38	40	42	44	46	48	50	52	54	56	m					
			4000	4000	3730	3510	3300	3030	2870	2670	2540	2400	2300	2130	2000	kg					

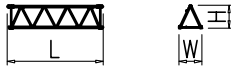
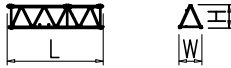
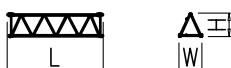
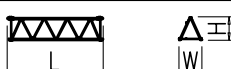
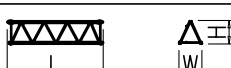
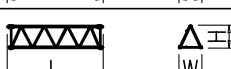
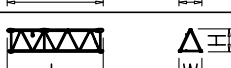
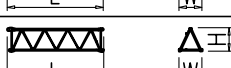
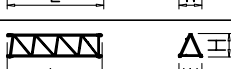
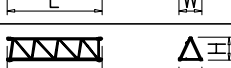

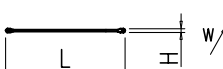

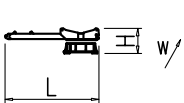

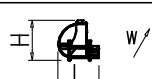

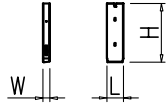

Pmax 8000/4000 kg

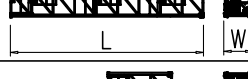
	25600 kg		3.5	16	20	24	28	30	34	36	38	40	42	44	46	48	50	52	54	56	58	60	62	65	m
			8000	8000	6360	5190	4360	4000	3360	3190	2940	2770	2490	2350	2220	2110	1950	1850	1760	1650	1570	1500	1300	1000	kg
	25600 kg		3.5	16	20	24	28	30	34	36	38	40	42	44	46	48	50	52	54	56	58	60	63	m	
			8000	8000	6360	5190	4360	4000	3360	3190	2940	2770	2490	2350	2220	2110	1950	1850	1760	1650	1570	1500	1300	kg	
	25600 kg		3.5	16	20	24	28	30	34	36	38	40	42	44	46	48	50	52	54	56	58	60	m		
			8000	8000	6360	5190	4360	4000	3480	3250	3050	2860	2700	2550	2410	2280	2170	2060	1960	1870	1780	1700	kg		
	25600 kg		3.5	18	20	24	28	30	34	36	38	40	42	44	46	48	50	52	54	56	m				
			8000	8000	7500	6150	5190	4810	4000	3730	3510	3300	3030	2870	2670	2540	2400	2300	2130	2000	kg				

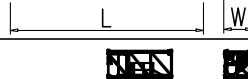
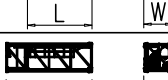
PESI E INGOMBRI – PACKING LIST – LISTE DE COLISAGE – GEWICHT UND ABMESSUNGEN

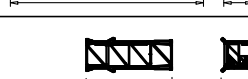
Denominazione Description	Disegno Draw	Pezzi Pieces	Dimensioni-Dimensions (mm)			Peso-Weight (kg)		
			L	W	H	Unit	Total	
Elemento di braccio Jib element Elément de èche Elemento de flecha	n°1 	1	5760	1440	1600	950	–	
	n°2 	1	5820	1400	1470	750	–	
	n°3 	1	5860	1400	1470	810	–	
	n°4 	1	5860	1400	1470	730	–	
	n°5 	1	5860	1400	1470	740	–	
	n°6 	1	5850	1400	1470	700	–	
	n°7 	1	5820	1400	1470	680	–	
	n°8 	1	5820	1400	1470	740	–	
	n°9 	1	5850	1400	1450	520	–	
	n°10 	1	5740	1400	1450	410	–	
	n°11 	1	5770	1400	1450	330	–	
	n°12 	1	4350	1400	1450	320	–	
	Punta 	1	800	1400	1400	170	–	
Tirante completo Complete tie rod Tirant complète Tirante completo		12	6500	200	200	240	3540	
Cuspide Cusp Pointre Cùspide		1	8300	1500	1000	2700	–	
Contorbraccio completo Complete counterjib Contreflèche complète Contraflecha completa		1	9300	1650	600	2000	–	
Gruppo girevole Slewing group Table tournante Grupo giratorio		SK1700	1	5100	1810	1400	6000	–
		SN2050	1	5100	1810	1400	6300	–
Carrello Trolley Chariot Carretilla		1	1900	1620	1000	400	–	
Ballatoio con cabina Access balcony with cabin Porte cabine Balcòn corrido con cabina		1	2500	2150	2450	1000	–	

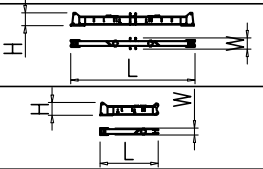
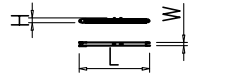
PESI E INGOMBRI – PACKING LIST – LISTE DE COLISAGE – GEWICHT UND ABMESSUNGEN

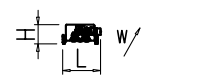
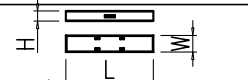
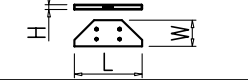
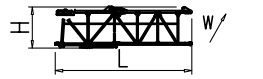
Denominazione Description	Disegno Draw	Pezzi Pieces	Dimensioni-Dimensions (mm)			Peso-Weight (kg)		
			L	W	H	Unit	Total	
Blocchi contrappeso Counterweight block Contre-poids Bloques de contrapeso	VX28 	9	1100	280	3700	2840	25600	
Elemento di torre Mast element Elément de mature Elemento de torre	ST039 	SK1700	-	3900	1785	1785	1750	-
		SN2050	-	3900	2110	2110	2320	-
	ST052 	SK1700	-	5200	1785	1785	2250	-
		SN2050	-	5200	2110	2110	2850	-
	ST117 	SK1700	-	11700	1785	1785	4690	-
		SN2050	-	11700	2110	2110	5790	-
	SB039 	SK1700	-	3900	1785	1785	2100	-
		SN2050	-	3900	2110	2110	2710	-
	SB052 	SK1700	-	5200	1785	1785	2600	-
		SN2050	-	5200	2110	2110	3350	-
SB117 	SK1700	-	11700	1785	1785	4830	-	
	SN2050	-	11700	2110	2110	7000	-	
BF039 	SK1700	-	3900	1785	1785	2450	-	
	SN2050	-	3900	2110	2110	3370	-	
BF052 	SK1700	-	5200	1785	1785	3390	-	
	SN2050	-	5200	2110	2110	3880	-	
BF117 	SK1700	-	11700	1785	1785	6920	-	
	SN2050	-	11700	2110	2110	8180	-	
Elemento di base Base element Mat de base Elemento de base	BA052 	SK1700	1	5200	2060	2060	3650	-
		SN2050	1	5200	2260	2260	4040	-
Carro di base Base carriage Chassis de base Cruceta de base		5x5	1	7550	670	780	2300	2300
		6x6	1	8870	670	780	2500	2500
		5x5	2	3530	420	780	1060	2120
		6x6	2	4320	420	780	1200	2400
Puntoni di base Rafter Jambes de force Cabrios de base		5x5	4	4250	240	300	280	1120
		6x6	4	4560	420	300	420	1680
Elemento a perdere Disposable frame Chassis a perdre Bastidor desechable		SK1700	1	1840	1910	1910	1430	-
		SN2050	1	2600	2260	2260	2030	-
Elemento recuperabile Recoverable frame Chassis récupérable Bastidor recuperable		SK1700	1	1300	2170	2170	1720	-
		SN2050	1	1300	2620	2620	1860	-
Bogie di traslazione Driven bogie Boggie motorisée Balancin de traslaciòn		4	1160	700	600	700	2800	
Blocco zavorra di base Base ballast block Lest de base Blaque de lastre		5x5	2	5300	1000	600	7300	14600
		6x6	2	6400	1200	600	10600	21200
		5x5	-	4100	1600	300	3500	-
		6x6	-	4800	2000	300	5070	-
Corsoio di montaggio Climbing cage Cage de montage Jaula de montaje		SK1700	1	8300	2600	2500	6000	-
		SN2050	1	8300	2900	2700	6700	-

GRU IN CAVEDIO – TELESCOPAGE SUR DALLES – CLIMBING CRANE – KLETTERKRANE IM GEBAUDE

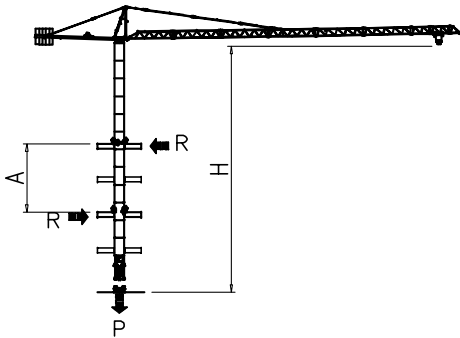

SN2050	H (m)	A (m)	R (t)	P (t)
	9	9	45.3	
	10	10	42	
	11	11	39.3	
	12	12	37	
	13	13	35	
	14	14	33.4	
	15	15	32	
	16	16	30.7	
	17	17	29.6	
	18	18	28.6	
<p>Apertura passaggio gru Opening for crane passing</p>	19	27.8		
	20	27		



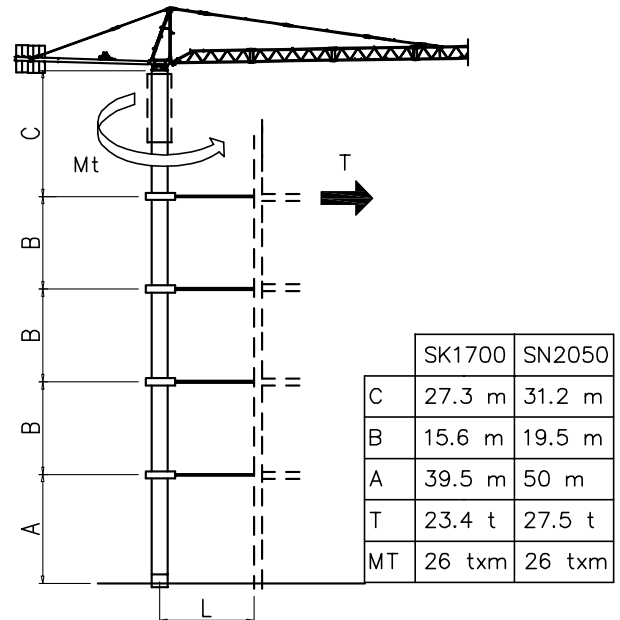
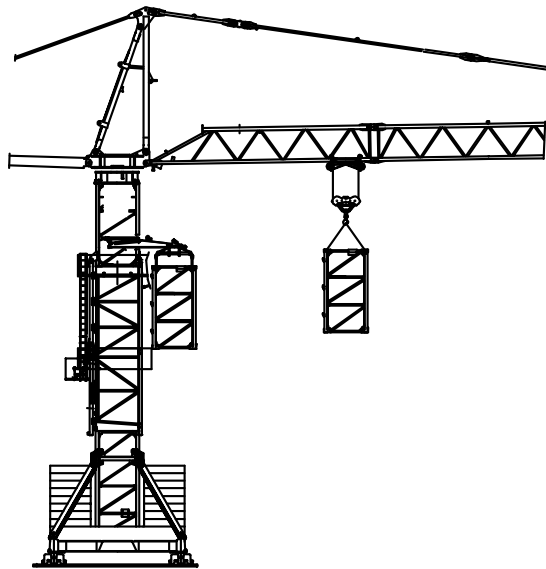

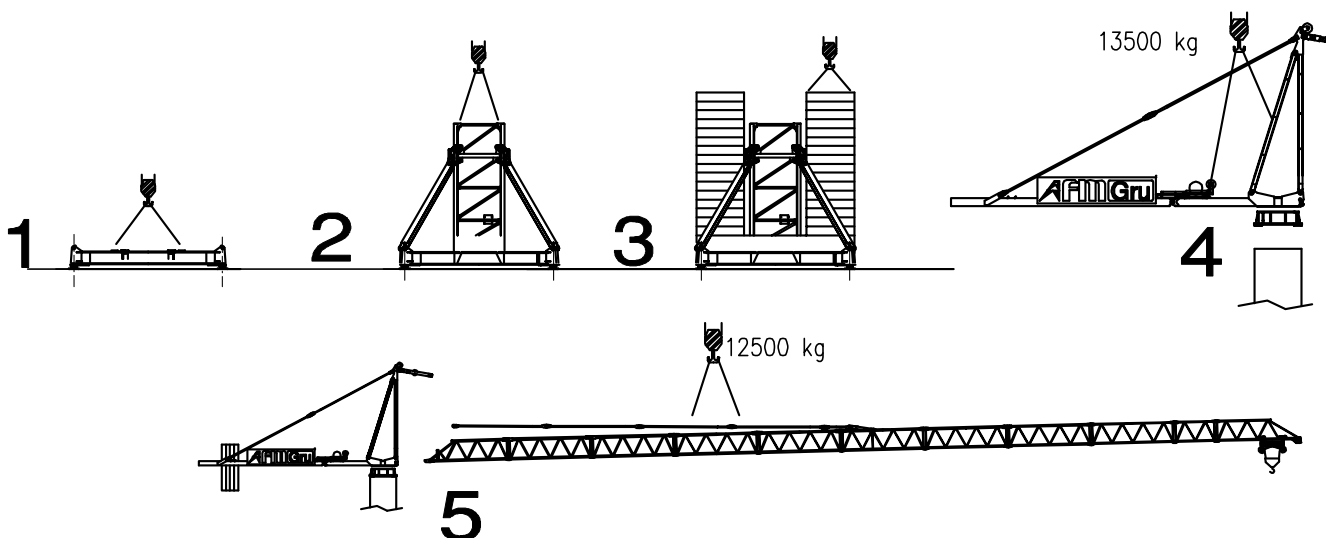

\* SOPRALZO IDRAULICO – TELESCOPABLE – EXTERNAL CLIMBING – KLETTERKRANE



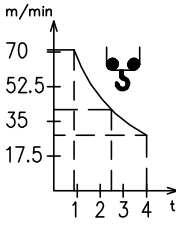
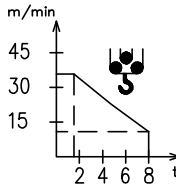
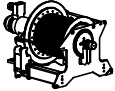

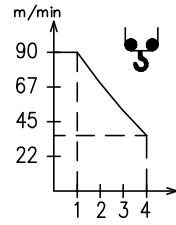
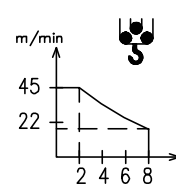
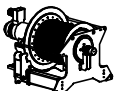

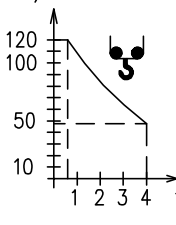
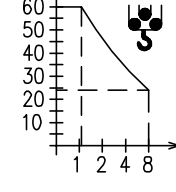
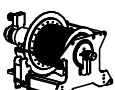
Montaggio – Montage – Erection – Montage – Montaje – Montagem



Meccanismi – Mechanisms – Mécanismes – Antriebe – Mecanismos

Sollevamento V33.60 Hoisting Levage Heben Elevaciõn Elevaçao									V33.60 24 kW 40 kVA    260 m
	m/min	2.5	15	27	43	56			
	t	4	4	4	2.5	1.7	0.8		
									
	m/min	1.2	7.5	13.5	21.5	28	35.5		
	t	8	8	8	5	3.4	1.6		
Sollevamento V45.90 Hoisting Levage Heben Elevaciõn Elevaçao									V45.90 33 kW 58 kVA    340 m 700 m (L)
	m/min	4	18	36	56	74			
	t	4	4	4	3	2	1		
									
	m/min	2	9	18	28	37	45		
	t	8	8	8	6	4	1		
Sollevamento V50.100 Hoisting Levage Heben Elevaciõn Elevaçao									V50.100 37 kW 60 kVA    270 m 500 m (L)
	m/min	4	22	48	84	100			
	t	4	4	4	2	1.5	0.6		
									
	m/min	2	11	24	42	50	60		
	t	8	8	8	4	3	1.2		

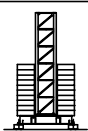
Carrello Trolleying Distribution Katzfahren Distribuciõn Distribuiçao			0 → 85	m/min	3.6 kW	Potenza elettrica necessaria Puissance électrique nécessaire Necessary electric power Anschlusswert – Potencia
Rotazione Slewing Orientation Schwenken Orientaciõn Rotaçao			0 → 0,9	giri/min tr/min rp/min	4.4 kW @ 1200rpm n° 2 x 2.2 kW	
Traslazione Travelling Translation Kranfahren Traslaciõn Traslaçao			0 → 20	m/min	7.5 kW	

Rete elettrica – Réseau – Mains supply – Netzstrom – Red – Rede electrica 400V – 50 Hz

Rete elettrica – Réseau – Mains supply – Netzstrom – Red – Rede electrica 400V – 50 Hz

**AFM Gru** FMgru s.r.l.  
 via Emilia 11-29010 Pontenure PC ITALY  
 tel. 0523/510446 ric.aut. fax 0523/510365  
 www.fmgru.it e-mail: info@fmgru.com

FEM 1.001  
2000/14/CE



Documento commerciale non contrattuale  
 Per tutte le informazioni tecniche riferirsi  
 alle corrispondenti istruzioni

Unverbindliches Vertriebsdokument.  
 Für technische Informationen, siehe die  
 entsprechenden Anweisungen.

This commercial document is not legally  
 binding. For any technical information, please  
 refer to the corresponding instructions.

Documento comercial no contractual  
 Para cualquier información técnica,  
 ver la noticia correspondiente.

Code: 15ICA37K35A1		
Ed.	Data	Rev Data
1	05.06.03	2 17.03.10