

FLAT TOP TOWER CRANE

**Specifications:**

- ▶ Max jib length: 50,00 m
- ▶ Capacity at max length: 1,40 t
- ▶ Max capacity: 5,00 t

WORKS FOR YOU.™

KEY

Zeichenerklärung · Légende · Leyenda · Legenda



Hoisting · Heben · Levage · Elevación · Sollevamento



Trolleying · Katzfahren · Distribution · Distribución · Traslazione carrello



Slewing · Schwenken · Orientation · Orientació · Rotazione



Travelling · Schienenfahren · Translation · Traslación · Traslazione



Directive on noise level · Richtlinie für den Schall-Leistungspegel · Directive sur le niveau acoustique · Directiva sobre el nivel acustico · Direttiva sul livello acustico



Consult us · Auf Anfrage · Nous consulter · Consultarnos · Consultateci



Power requirements · Geforderte Stromstärke · Puissance totale nécessaire · Potencia necesaria · Potenza totale richiesta



Power supply · Stromversorgung · Alimentation · Alimentación · Alimentazione



In service · In Betrieb · En service · En servicio · In servizio



Out of service · Außer Betrieb · Hors service · Fuera de servicio · Fuori servizio



Max. under hook height · Höchste Hakenhöhe · Hauteur maxi. sous crochet · Maxima altura bajo gancho · Altezza max. sotto gancho



Without load, without ballast, max. jib and max. height · Ohne Last und Ballast, mit Maximalausleger und Maximalhöhe · A vide, sans lest, avec flèche et hauteur maximum · Sin carga, sin lastre, con pluma y altura máxima · A vuoto, senza zavorra, braccio max., altezza max.



Counterweight · Gegengewicht · Lest de contre-flèche · Lastre de contra flecha · Zavorra controbraccio

C25

FEM 1004 Out of service wind condition · FEM 1004 Windverhältnisse im Außerbetriebszustand · FEM 1004 Conditions de vent hors service · FEM 1004 Condiciones de viento fuera de servicio · FEM 1004 Condizioni del vento in fuori servizio

CONTENTS

CTT 91-5 TS12

Inhalt · Contenu · Contenido · Indice

Page · Seite · Page · Pàgina · Pagina:

Load Diagram · Lastkurven · Courbes de charges · Curvas de cargas · Diagramma di portata	4
Tower · Turm · Tour · Torre · Torre	6
Mechanisms · Antriebe · Mécanismes · Mecanismos · Meccanismi	7
Transportation · Transport · Transportation · Transportation · Trasporto	9

LOAD DIAGRAM

Lastkurven · Courbes de charges · Curvas de cargas · Diagramma di portata

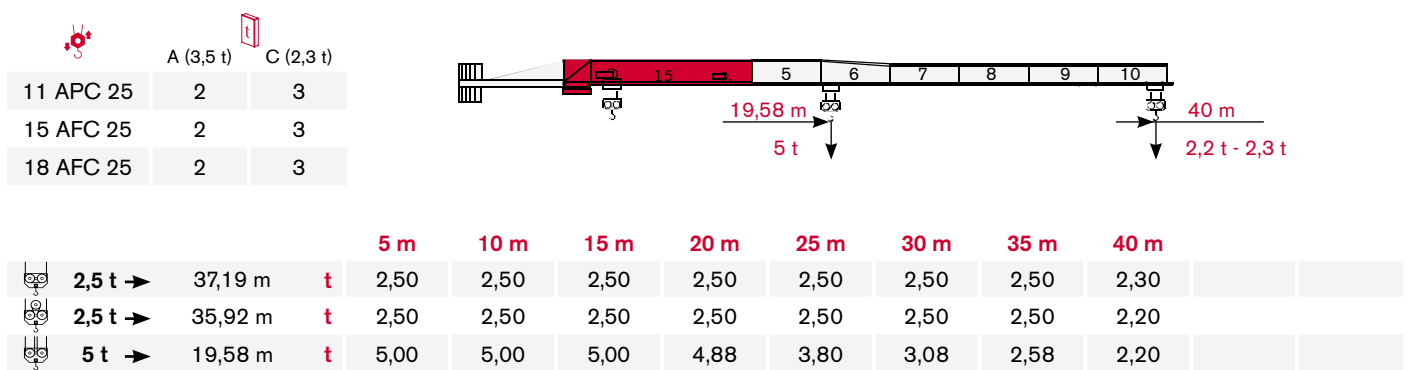
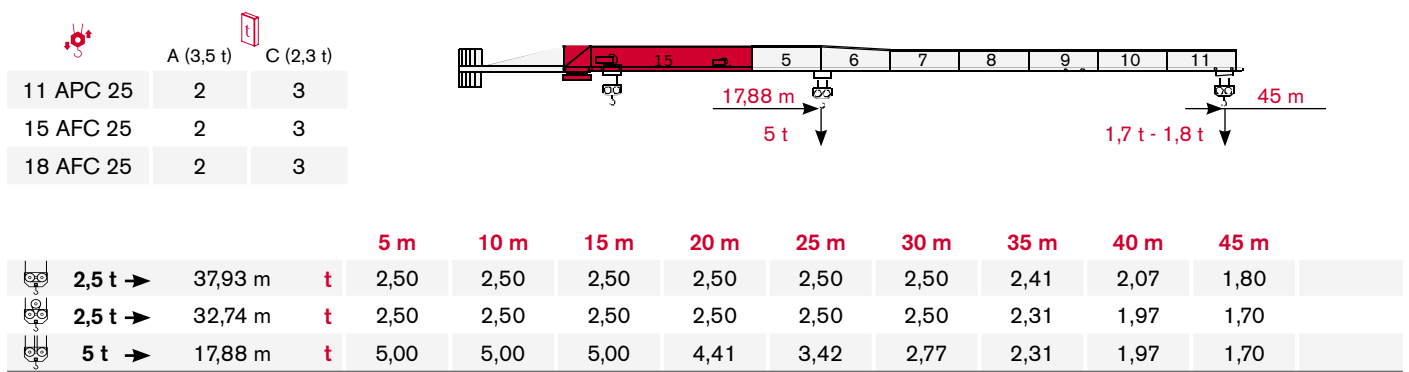
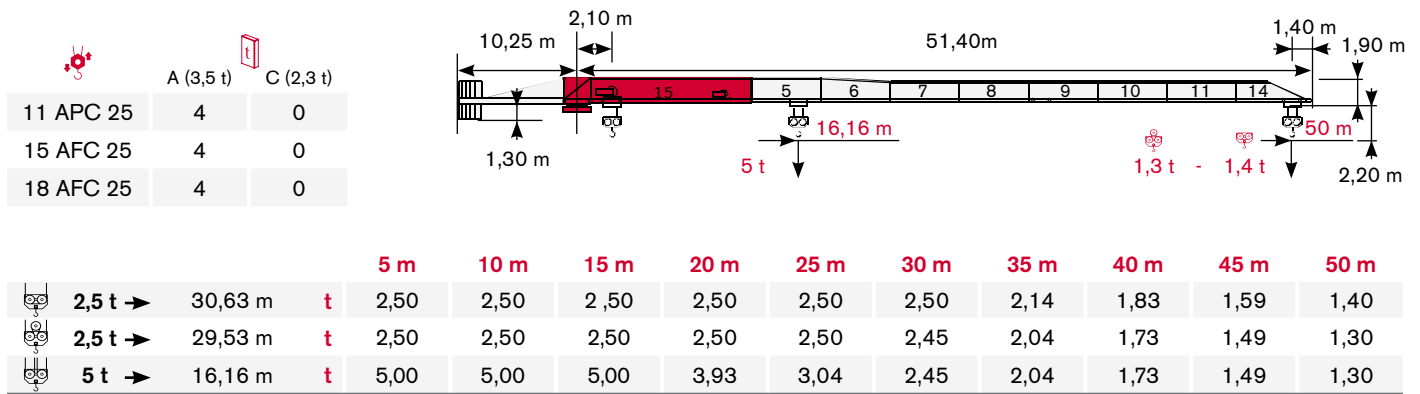

		A (3,5 t)	C (2,3 t)
11 APC 25		3	1
15 AFC 25		3	1
18 AFC 25		3	1

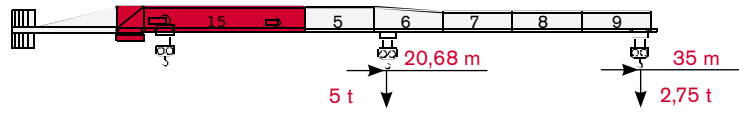

			5 m	10 m	15 m	20 m	25 m	30 m	35 m				
	2,5 t →	35,00 m	t	2,50	2,50	2,50	2,50	2,50	2,50				
	5 t →	20,68 m	t	5,00	5,00	5,00	5,00	4,04	3,29	2,75			

		A (3,5 t)	C (2,3 t)
11 APC 25		2	2
15 AFC 25		2	2
18 AFC 25		2	2

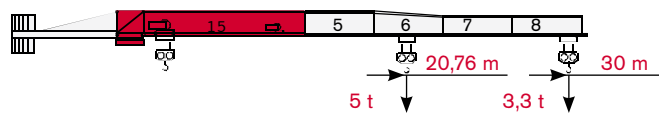

			5 m	10 m	15 m	20 m	25 m	30 m					
	2,5 t →	30,00 m	t	2,50	2,50	2,50	2,50	2,50					
	5 t →	20,76 m	t	5,00	5,00	5,0	5,00	4,06	3,30				

		A (3,5 t)	C (2,3 t)
11 APC 25		1	3
15 AFC 25		1	3
18 AFC 25		1	3

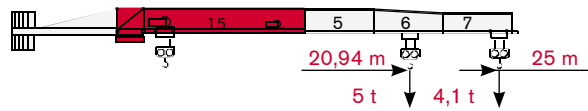

			5 m	10 m	15 m	20 m	25 m						
	2,5 t →	20,00 m	t	2,50	2,50	2,50	2,50	2,50					
	5 t →	20,94 m	t	5,00	5,00	5,00	5,00	4,10					

TOWER

Turn · Tour · Torre · Torre

Standard Configurations · Standardkonfiguration · Standard Implantations · Implantaciones Standard · Installazioni Standard

Tower: TS12 & Basement: R1

	●	◊
R1	-1385 kN	-2023 kN
R2	1138 kN	1795 kN
	296 kN	

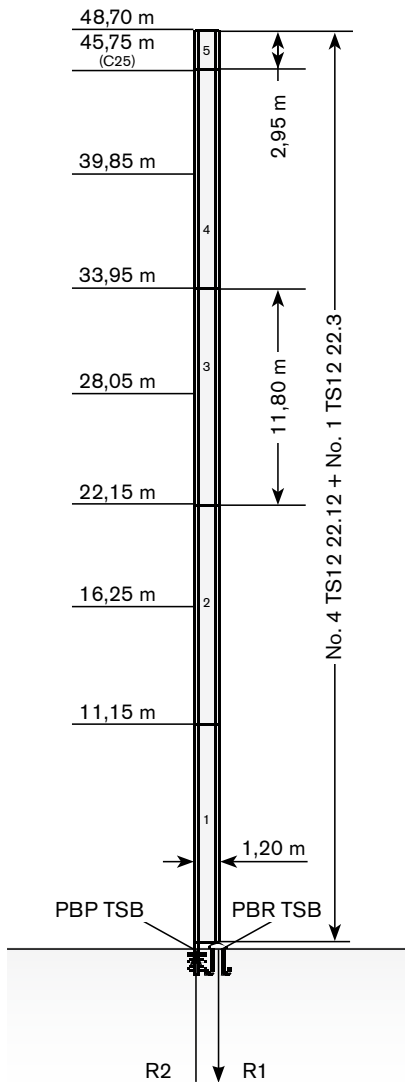

Tower: TS12 & Basement: F1

	●	◊
R1	-582 kN	-796 kN
R2	-52 kN	0
	300 kN	

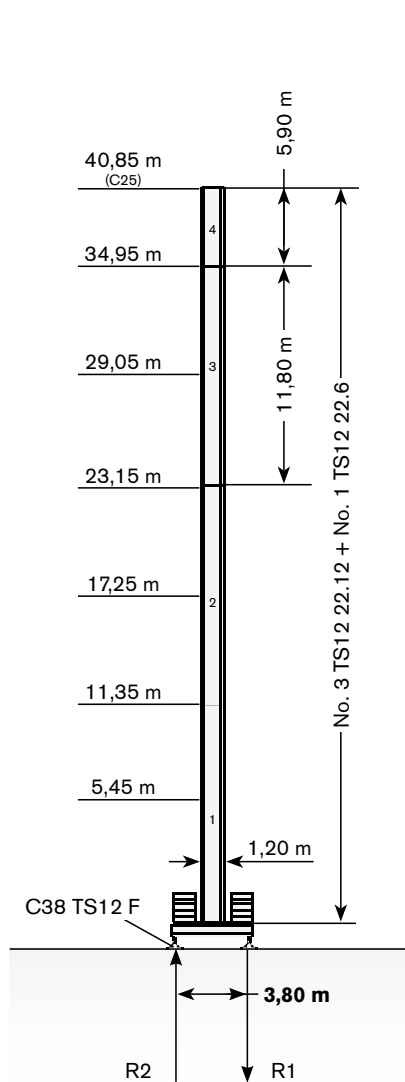

Tower: TS12 & Basement: FP1



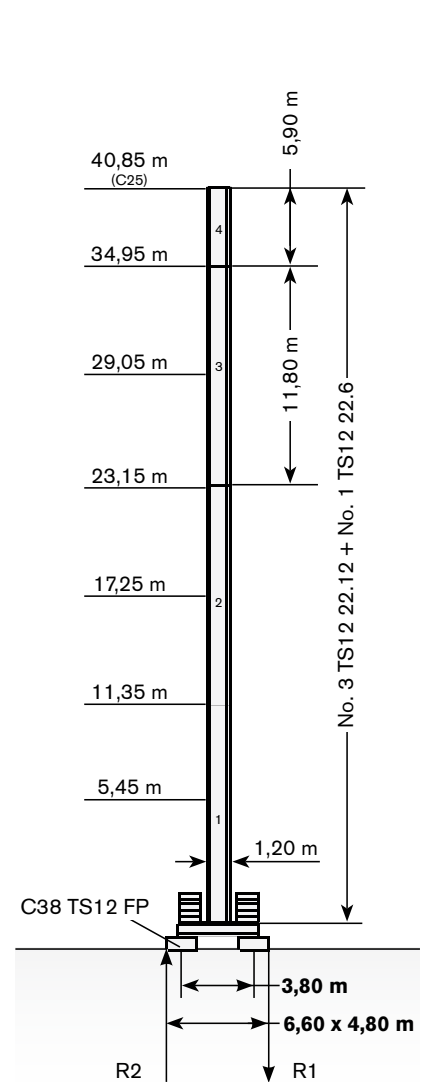



	●	◊
R1	-582 kN	-796 kN
R2	-52 kN	0
	300 kN	



Max. under hook height · Höchstes Hakenhöhe · Hauteur maxi. sous crochet · Maxima altura bajo gancho · Altezza max. sotto gancio









Different heights, tower combinations and travelling are available; please consult us · Andere Höhen, Turmkombinationen und Schienenfahrwerk auf Anfrage · Différentes hauteurs, combinaisons de tour et translation sont disponibles; nous consulter · Hay diferentes alturas, combinaciones de torre y traslación disponibles. Consultémos · Altezze diverse, combinazioni di torre e traslazioni sono disponibili; consultateci

The available lengths for the TS tower sections are 11.8 m, 5.9 m, 2.95 m. · Die Turmschüsse TS sind mit Längen 11.8 m, 5.9 m, 2.95 m verfügbar. · Les éléments de mât TS sont disponibles en longueur 11.8 m, 5.9 m, 2.95 m. · Los tramos de torre TS son disponibles en las medidas de largo 11.8 m, 5.9 m, 2.95 m. · Le prolunghe TS sono disponibili in lunghezze 11.8 m, 5.9 m, 2.95 m.

				
	11 APC 25	31 kVA*	400V - 50Hz	2000/14/CE modificata
	15 AFC 25	40 kVA*	400V - 50Hz / 460V - 60Hz	2000/14/CE modificata
	18 AFC 25	41 kVA*	400V - 50Hz / 460V - 60Hz	2000/14/CE modificata

* Crane without travelling equipment – Three movements simultaneous at 90% · Krane ohne Schienenfahren – Drei gleichzeitige Bewegungen mit 90% · Grue sans translation – Trois mouvements simultanés à 90% · Grúa sin traslación – Tres movimientos contemporáneos hechos al 90% · Gru senza traslazione – Tre movimenti contemporanei al 90%

Hoisting · Heben · Levage · Elevación · Sollevamento

			t	m/min	kW	
	11 APC 25		2,5	6	11	186 m
			2,5	20		
			1,25	40		
			5	3		
			5	10		
			2,5	20		
	15 AFC 25 (Variant)		2,5	0 → 1,7	15	186 m
			2,5	1,7 → 6		
			2,5	6 → 28		
			1,44	28 → 46		
			1,1	46 → 57		
			5	0 → 0,85		
			5	0,85 → 3		
			5	3 → 14		
			2,88	14 → 23		
			2,2	23 → 28,5		
	18 AFC 25 (Variant)		2,5	0 → 2,2	18	310 m
			2,5	2,2 → 8		
			2,5	8 → 34		
			1,46	34 → 55		
			1,1	55 → 69		
		5	0 → 1,1			
		5	1,1 → 4			
		5	4 → 17			
		2,92	17 → 27,5			
		2,92	27,5 → 34,5			

MECHANISMS

Antriebe · Mécanismes · Mecanismos · Meccanismi

Hoisting Speed · Heben Geschwindigkeit · Vitesse de Levage ·
Velocidad de Elevación · Velocità' di Sollevamento

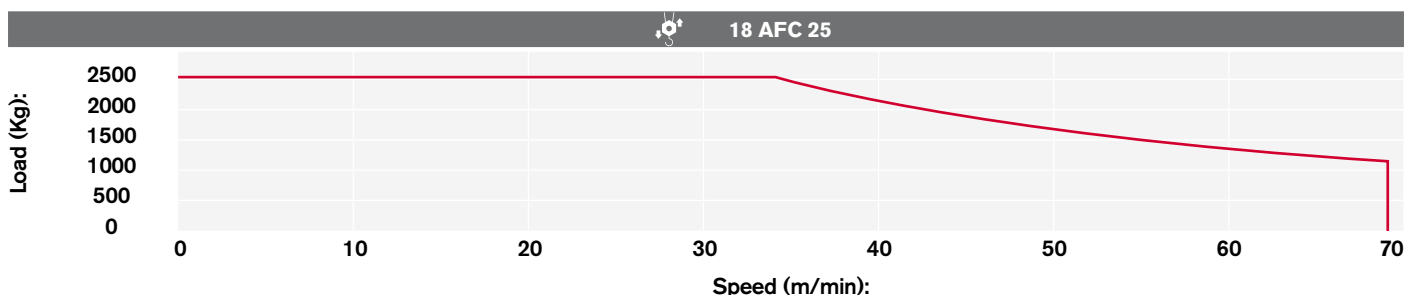
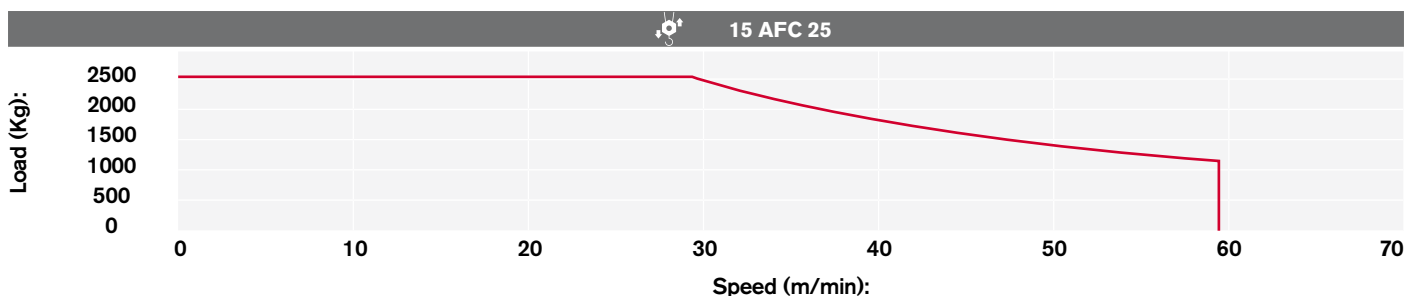
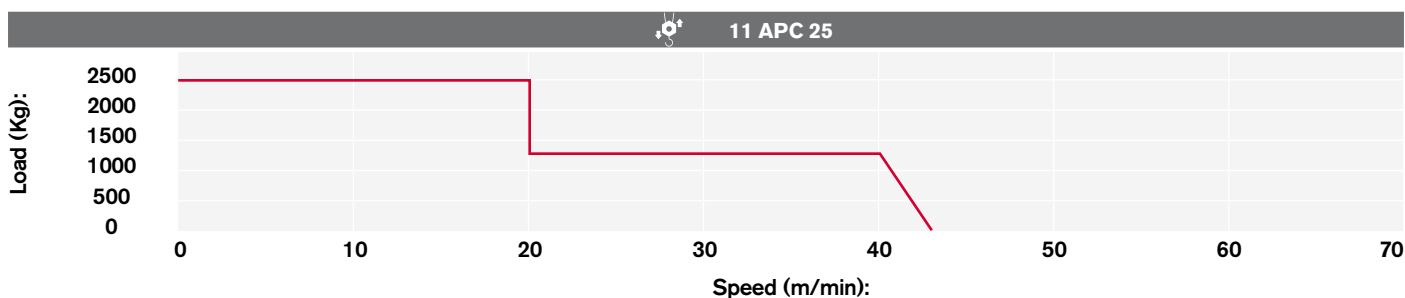

Additional Specifications · Weitere Leistungsdaten ·
Spécifications additionnelles · Otras prestaciones · Altre movimentazioni







	DAD 2 2 D1	0 → 22 → 44 m/min	2,2 - 1,5 kW
	DVF 3 4 D5 (Variant)	0 → 6 → 30 → 60 m/min	4 kW
	SSR 1 1 65	0,76 r.p.m.	1 x 65 Nm

TRANSPORTATION

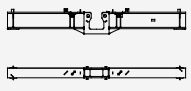
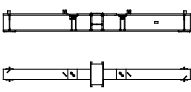
CTT 91-5 TS12

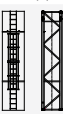
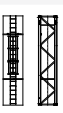
Transport · Transport · Conducción · Trasporto

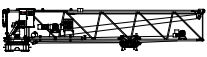
Packing list

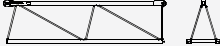
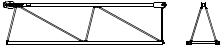
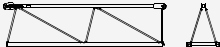
CTT 91-5/TS12	DESCRIPTION · BESCHREIBUNG · DESCRIPTION · DESCRIPCIÓN · DESCRIZIONE	LENGTH · LÄNGE · LONGUEUR · LONGITUD · LUNGHEZZA	WIDTH · BREITE · LARGEUR · ANCHURA · LARGHEZZA	HEIGHT · HÖHE · HAUTEUR · ALTURA · ALTEZZA	QUANTITY · MENGE · QUANTITÉ · CANTIDAD · QUANTITÀ	WEIGHT · GEWICHT · POIDS · PESO · PESO
	"A" BEAM FOR C38 UNDERCARRIAGE	5,80 m	0,40 m	0,80 m	1	2172 kg
	"B" BEAM FOR C38 UNDERCARRIAGE	5,80 m	0,75 m	0,65 m	1	2086 kg
	TS12 22.12 NORMAL TOWER SECTION	1,23 m	1,26 m	11,80 m	1	4032 kg*
	TS12 22.12 BASE TOWER SECTION	1,21 m	1,26 m	11,80 m	1	4025 kg*
	TS12 22.6 NORMAL TOWER SECTION	1,22 m	1,26 m	5,90 m	1	2102 kg*
	TS12 22.6 BASE TOWER SECTION	1,21 m	1,26 m	5,90 m	1	2097 kg*
	TS12 22.3 NORMAL TOWER SECTION	1,22 m	1,26 m	2,95 m	1	1179 kg*
	SLEWING UNIT INCLUDING JIB SECTION-15	12,10 m	2,00 m	2,44 m	1	5640 kg
	PLATFORM UNIT INCLUDING CAB	2,50 m	1,60 m	2,50 m	1	1110 kg
	COUNTERJIB COMPLETE	9,70 m	0,75 m	1,35 m	1	1948 kg
	JIB SECTION-5	5,20 m	1,11 m	1,80 m	1	530 kg
	JIB SECTION-6	5,20 m	1,11 m	1,80 m	1	510 kg
	JIB SECTION-7	5,20 m	1,11 m	1,30 m	1	450 kg

* inclusive of ladders, platforms, protections and erection equipment

TRANSPORTATION

Transport · Transport · Conducción · Trasporto

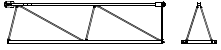
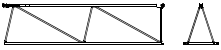
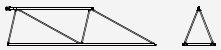
CTT 91-5/TS12	DESCRIPTION · BESCHREIBUNG · DESCRIPTION · DESCRIPCIÓN · DESCRIZIONE	LENGTH · LÄNGE · LONGUEUR · LONGITUD · LUNGHEZZA	WIDTH · BREITE · LARGEUR · ANCHURA · LARGHEZZA	HEIGHT · HÖHE · HAUTEUR · ALTURA · ALTEZZA	QUANTITY · MENGE · QUANTITÉ · CANTIDAD · QUANTITÀ	WEIGHT · GEWICHT · POIDS · PESO · PESO
	JIB SECTION-8	5,20 m	1,11 m	1,30 m	1	400 kg
	JIB SECTION-9	5,20 m	1,11 m	1,30 m	1	280 kg
	JIB SECTION-10	5,20 m	1,11 m	1,30 m	1	276 kg
	JIB SECTION-11	5,20 m	1,11 m	1,30 m	1	223 kg
	JIB SECTION-14	5,20 m	1,11 m	1,30 m	1	170 kg
	JIB POINT SECTION	1,20 m	0,70 m	1,10 m	1	55 kg
	HOIST WINCH 11 APC 25 F9	1,30 m	1,20 m	0,50 m	1	460 kg
	HOIST WINCH 15 AFC 25 F9	1,30 m	1,20 m	0,50 m	1	460 kg
	18 AFC 25 F9 HOIST WINCH (with electric box and resistance box)	1,55 m	1,33 m	0,74 m	1	555 kg

www.terexcranes.com

Effective Date: January 2011.

Product specifications and prices are subject to change without notice or obligation. The photographs and/or drawings in this document are for illustrative purposes only. Refer to the appropriate Operator's Manual for instructions on the proper use of this equipment. Failure to follow the appropriate Operator's Manual when using our equipment or to otherwise act irresponsibly may result in serious injury or death. The only warranty applicable to our equipment is the standard written warranty applicable to the particular product and sale and Terex makes no other warranty, express or implied. Products and services listed may be trademarks, service marks or trade-names of Terex Corporation and/or its subsidiaries in the USA and other countries. All rights are reserved. Terex® is a registered trademark of Terex Corporation in the USA and many other countries.

Gültig ab: Januar 2011.

Produktbeschreibungen und Preise können jederzeit und ohne Verpflichtung zur Ankündigung geändert werden. Die in diesem Dokument enthaltenen Fotos und/oder Zeichnungen dienen rein anschaulichen Zwecken. Anweisungen zur ordnungsgemäßen Verwendung dieser Ausrüstung entnehmen Sie bitte dem zugehörigen Betriebshandbuch. Nichtbefolgung des Betriebshandbuchs bei der Verwendung unserer Produkte oder anderweitig fahrlässiges Verhalten kann zu schwerwiegenden Verletzungen oder Tod führen. Für dieses Produkt wird ausschließlich die entsprechende, schriftlich niedergelegte Standardgarantie gewährt. Terex leistet keinerlei darüber hinaus gehende Garantie, weder ausdrücklich noch stillschweigend. Die Bezeichnungen der aufgeführten Produkte und Leistungen sind gegebenenfalls Marken, Servicemarken oder Handelsnamen der Terex Corporation und/oder ihrer Tochtergesellschaften in den USA und anderen Ländern. Alle Rechte vorbehalten. „TEREX“ ist eine eingetragene Marke der Terex Corporation in den USA und vielen anderen Ländern.

Date d'effet : Janvier 2011.

Les spécifications et prix des produits sont sujets à modification sans avis ou obligation. Les photographies et/ou dessins contenus dans ce document sont uniquement pour illustration. Veuillez vous référer à la notice d'utilisation appropriée pour les instructions quant à l'utilisation correcte de cet équipement. Tout manquement au suivi de la notice d'utilisation appropriée lors de l'utilisation de notre équipement ou tout acte autrement irresponsable peut résulter en blessure corporelle sérieuse ou mortelle. La seule garantie applicable à notre équipement est la garantie standard écrite applicable à un produit et à une vente spécifique. Terex n'offre aucune autre garantie, expresse ou explicite. Les produits et services proposés peuvent être des marques de fabrique, des marques de service ou des appellations commerciales de Terex Corporation et/ou ses filiales aux Etats Unis et dans les autres pays, et tous les droits sont réservés. «TEREX» est une marque déposée de Terex Corporation aux Etats Unis et dans de nombreux autres pays.

Fecha efectiva: Enero 2011.

Los precios y las especificaciones de productos pueden sufrir cambios sin aviso previo u obligación. Las fotografías o dibujos de este documento tienen un fin meramente ilustrativo. Consulte el manual de instrucciones del operador correspondiente para más información sobre el uso correcto de este equipo. El hecho de no respetar el manual del operador correspondiente al utilizar el equipo o actuar de forma irresponsable puede suponer lesiones graves o fatales. La única garantía aplicable a nuestro equipo es la garantía escrita estándar correspondiente a cada producto y venta, y TEREX no amplía dicha garantía de forma expresa o implícita. Los productos y servicios mencionados pueden ser marcas registradas, marcas de servicio o nombres de marca de TEREX Corporation o de sus filiales en Estados Unidos de América y otros países, y se reservan todos los derechos. „TEREX“ es una marca comercial registrada de Terex Corporation en Estados Unidos de América y muchos otros países.

Data di inizio validità: Gennaio 2011.

Ci riserviamo il diritto di modificare le specifiche e i prezzi dei prodotti in ogni momento e senza preavviso. Le fotografie e/o i disegni contenuti in questo documento sono destinati unicamente a scopi illustrativi. Consultare le istruzioni sull'uso corretto di questo macchinario, contenute nell'opportuno Manuale dell'operatore. L'inottemperanza delle istruzioni contenute nel Manuale dell'operatore del macchinario e altri comportamenti irresponsabili possono provocare gravi lesioni, anche mortali. L'unica garanzia applicabile ai nostri macchinari è la garanzia scritta standard applicabile al particolare prodotto e alla particolare vendita; Terex è esonerata dal fornire qualsiasi altra garanzia, esplicita o implicita. I prodotti e servizi elencati possono essere dei marchi di fabbrica, marchi di servizio o nomi commerciali di TEREX Corporation e/o società affiliate negli Stati Uniti d'America e altre nazioni e tutti i diritti sono riservati. „TEREX“ è un marchio registrato di Terex Corporation negli USA e molti altri Paesi.

Copyright 2011 Terex Corporation

Terex Cranes, Global Marketing, Dinglerstraße 24, 66482 Zweibrücken, Germany
Tel. +49 (0) 6332 830, Email: info.cranes@terex.com, www.terexcranes.com

Brochure Reference: TC-DS-M-E/F/G/I/S-CTT91-5 TS12-01/11



WORKS FOR YOU.™