





Gru automatica idraulica SMH 142



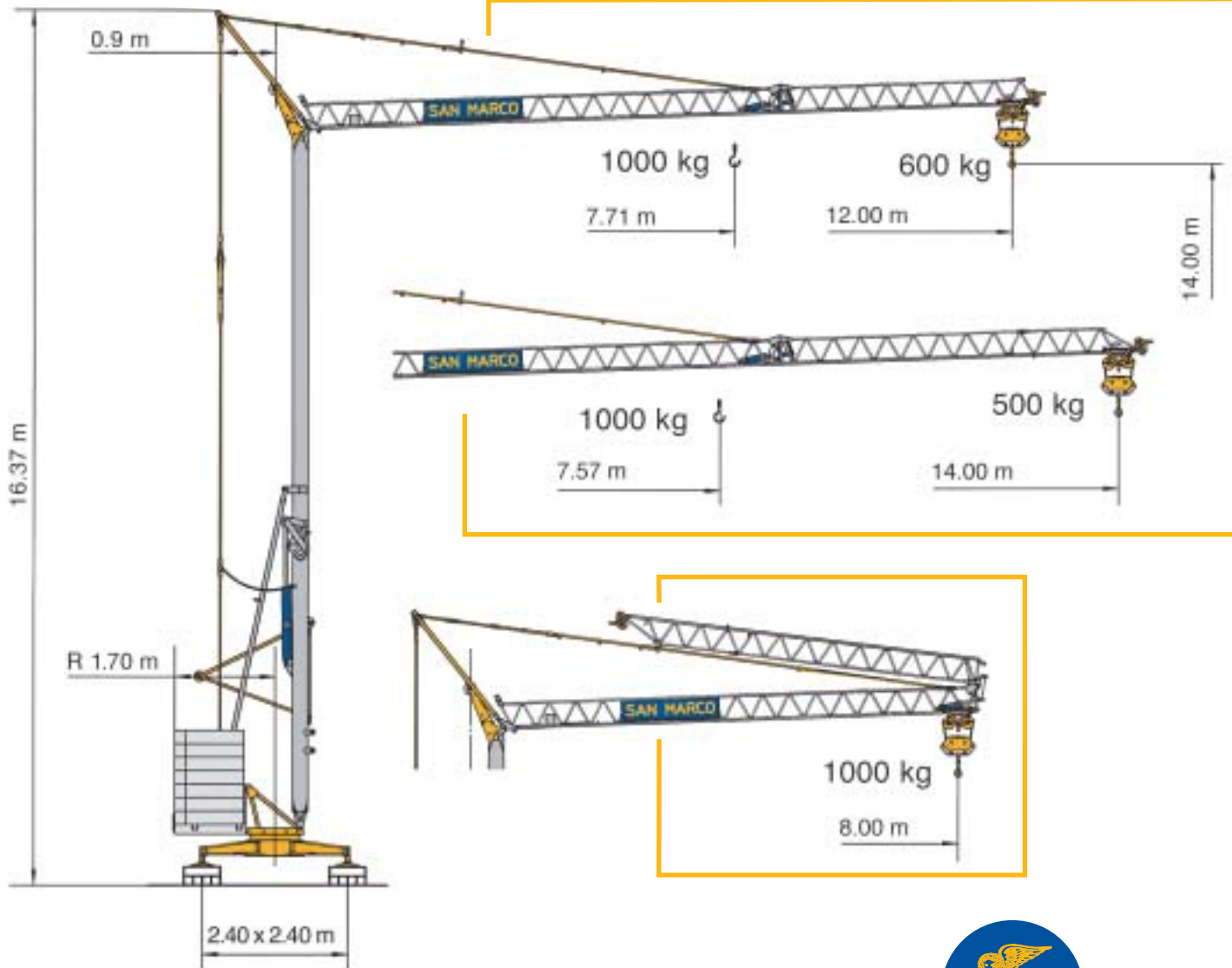
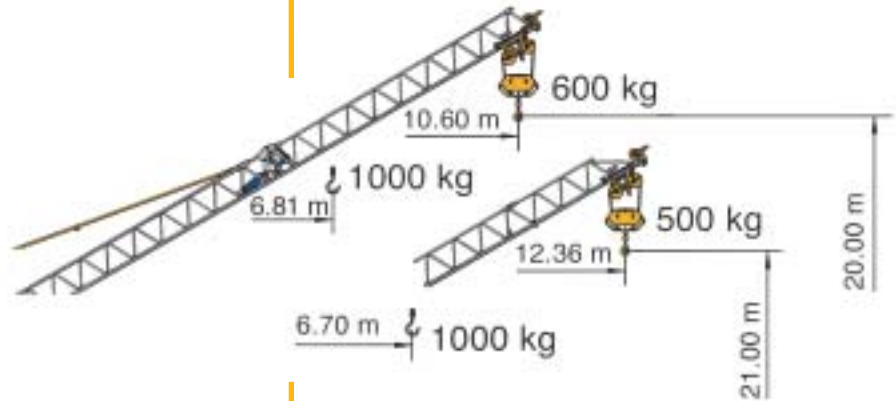

Triverter 444

-  Automatic crane hydraulic
-  Automatischer Hydraulischer Kran
-  Grue automatique hydraulique
-  Grua automatica hidraulica



DIN 15018 H1 B3
ISO 4301



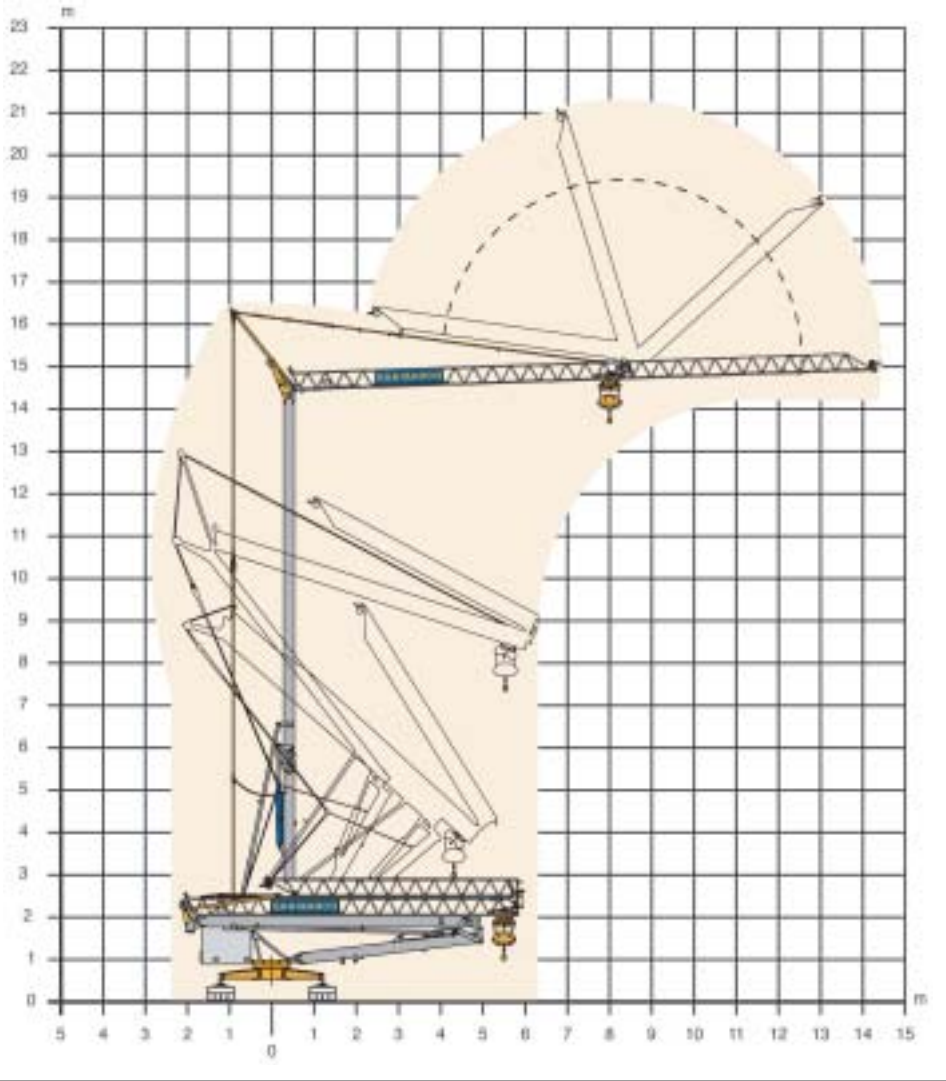

Montaggio

-  Erection
-  Montage
-  Montage
-  Montaje

kW 1.5



Reazioni (F) e pesi (P)

-  Reactions (F) - Loads (P)
-  Eckdrücke (F) - Krangewicht (P)
-  Réactions (F) - Poids (P)
-  Reacciones (F) - Pesos (P)



F	P
4.7 t	9.3 t

In servizio • In service
In Betrieb • En service
En servicio

F	P
2.5 t	8.2 t

Fuori servizio • Out of service
Ausser Betrieb • Hors service
Fuera de servicio

Diagrammi di carico

-  Loads diagrams
-  Lastkurven
-  Courbes de charges
-  Curvas de carga

Braccio impennato
Inclined jib
Schräggestellter Ausleger
Flèche relevée
Flecha inclinada



Kg	12	14
1000	6.81 m	6.70 m
900	7.22 m	7.10 m
800	8.10 m	7.95 m
700	9.20 m	9.02 m
600	10.60 m	10.40 m
500		12.36 m

Braccio orizzontale
Horizontal jib
Flèche horizontale
Waagerechter Ausleger
Flecha horizontal



Kg	12	14
1000	7.71 m	7.57 m
900	8.20 m	8.04 m
800	9.15 m	9.00 m
700	10.38 m	10.20 m
600	12.00 m	11.80 m
500		14.00 m

Freccia chiusa
Closed jib
Auslegerspitze zu
Flèche fermée
Flecha plegada



Kg	
1000	8.00 m

Gru automatica idraulica SMH 142

Triverter 444

Potenza elettrica necessaria

- Power requirement
- Anschlusswert
- Puissance électrique nécessaire
- Potencia eléctrica necesaria

	T	M
V	380	220
kW	5	3-6

Alimentazione elettrica

- Mains supply
- Netzstrom
- Réseau électrique
- Alimentación eléctrica

	T	M
V	380 (+5%)	220 (+5%)
Hz	50	50

Carrello - Variatore (Inverter)

- Trolley - Speed controller
- Katzfahren - Unrichter
- Chariot - Variateur
- Carro - Variador

m/min	7	14	21	28
kW	0.75			

Sollevamento - Variatore (Inverter)

- Hoisting - Speed controller
- Heben - Unrichter
- Levage - Variateur
- Elevación - Variador

	T				M			
m/min	6.5	13	18.5	26	6.5	13	18.5	22
kg	1000	1000	800	600	1000	1000	800	600
kW	4				4			

Rotazione - Variatore (Inverter)

- Stewing - Speed controller
- Schwenken - Unrichter
- Orientation - Variateur
- Orientación - Variador

rpm	0.25	0.5	0.75	0.9
kW	1.1			

Trasporto

- Transportation
- Transport
- Transport
- Transporte

P1 3050 kg	P2 2050 kg
P1 + P2 5100 kg	

Con assali e zavorra di montaggio • With axles and assembly counterweight • Mit transportachse und montiert Ballast • Avec essieux et lest de montage • Con ejes y contrapeso de montaje

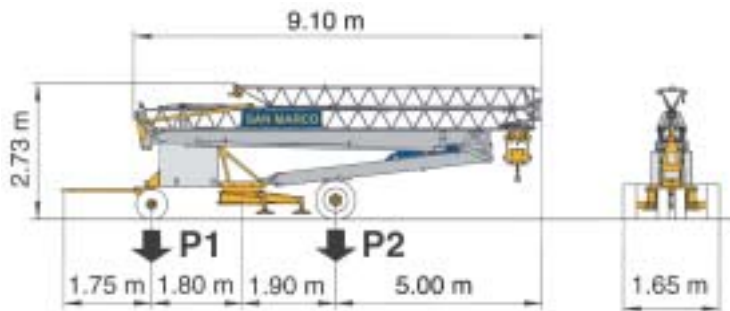

Assali sterzanti - spostamento laterale*

- Steering axles - lateral displacement*
- Steuerbare achsen - Seitenzustellung*
- Essieux pivotants - Desplacement lateral*
- Eje direccional - Desplazamiento lateral*

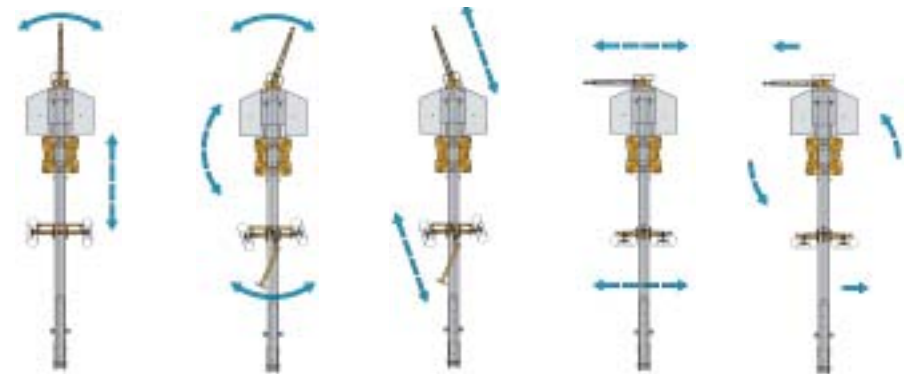

- Stierzante / Steering / Steuerbar / Simple pivotant / Direccional
- Doppio sterzante / Double steering / Doppelsteuerbar / Double pivotant / Direccional doble
- Spostamento obliquo / Oblique displacement / Schrage bewegung / Deplazamiento transversal / Desplazamiento oblicuo
- Spostamento laterale / Lateral displacement / Seitenzustellung / Desplazamiento lateral / Desplazamiento lateral
- Rotazione 360° / Rotation 360° / Drehung 360° / Virage 360° / Giro 360°

* a richiesta • on request • auf Wunsch • sur demande • sobre demanda

M monofase • single-phase • einphasig • monophasé • monofasica

T trifase • 3phase • dreiphasig • triphase • trifasica

media/grande velocità sollevamento • medium/major hoisting speed • mittel/große Hubgeschwindigkeit • moyenne/grande vitesse de levage • velocidad media/gran velocidad elevacion

media/grande velocità rotazione • medium/major rotation speed • mittel/große Drehgeschwindigkeit • moyenne/grande vitesse orientation • velocidad media/gran velocidad giro





media/grande velocità carrello • medium/major trolley speed • mittel/große Katzgeschwindigkeit • moyenne/grande vitesse chariot • velocidad media/gran velocidad carro

lontano sbraccio (sx) - vicino sbraccio (dx) • distant jib (sx) - near jib (dx) • Ausladung fern (sx) - Ausladung nah (dx) • fleche lointain (sx) - fleche proche (dx) • carro punta (sx) - carro torre (dx)

salita sollevamento (sx) - discesa sollevamento (dx) • load block up (sx) - load block down (dx) • Heben Hebevorgang (sx) - Senken Hebevorgang (dx) • montée levage (sx) - descente levage (dx) • subida de gancho (sx) - bajada de gancho (dx)

rotazione sinistra (sx) - rotazione destra (dx) • left rotation (sx) - right rotation (dx) • Drehung links (sx) - Drehung rechts (dx) • orientation gauche (sx) - orientation droite (dx) • giro izquierda (sx) - giro derecha (dx)

Le gru San Marco

-  San Marco Cranes
-  San Marco Kräne
-  Les grues San Marco
-  Las gruas San Marco

SMH Gru automatica idraulica
Automatic crane hydraulic
Automatischer Hydraulischer Kran
Grue automatique hydraulique
Grua automatica hidraulica

SMT Gru a torre montaggio modulare
Tower crane modular assembly
Turmdrehkran modulare montage
Grue a tour montage modulaire
Grua torre montaje modular

		L (m)																									
		12	14	18	20	22	24	25	26	27	28	30	32	34	36	38	40	42	44	45	46	48	50	52	55		
SMT	42																										42
	42																										42
	42																										42
	42																										42
	42																										42
SMH	28																										28
	26																										26
	23																										23
	22																										22
	22																										22
	19,5																										19,5
	18																										18
	16,5																										16,5
	16,5																										16,5
	14																										14

Strutture in acciaio ad alta resilienza per impiego a basse temperature • Zincatura torre e braccio con immersione a caldo secondo ISO 1461 • Bassa emissione acustica e livello di potenza sonora garantito e certificato • Possibilità di funzionamento a braccio impennato con carico variabile e carrello traslante • Climatizzazione termostatica dell'equipaggiamento elettrico per alte e basse temperature • Dispositivi di autolivellamento e autozavorramento.

 High resilience steel structures to be used at low temperature • Galvanised tower and jib with hot dipping in conformity ISO 1461 • Guaranteed and certified low acoustics emission and sound powers level • Possibility to work with inclined jib, traversing trolley and variable capacity • Automatic temperature control of electrical equipment for high and low temperatures • Full automatic devices for self levelling and ballast loader.

 Strukturen aus besonders schlagfesten Stahl für den Einsatz bei niedrigen Temperaturen • Turm und Ausleger lt. ISO 1461 heißverzinkt • Niedriger Geräuschpegel und Schallleistungsniveau garantiert und zertifiziert • Möglichkeit mit schräggestellten Ausleger mit wechselbaren Traglast und Laufkatze bei Abwinklung zu arbeiten • Thermostatgesteuerte Klimatisierung der elektrischen Ausrüstung für hohe und niedrige Temperaturen • Vorrichtungen zur Selbstnivellierung und Selbstballastierung.

 Charpente en acier à haute résilience pour utilisation en température ambiante froide • Galvanisation à chaud mat et fleche par immersion selon ISO 1461 • Émission acoustique réduite et niveau de puissance sonore garantie avec certificat • Possibilité de travailler avec fleche relevée, charge variable et chariot distributeur • Climatization thermostatique de l'équipement électrique pour températures ambiante élevées ou basses • Dispositifs automatiques de mise a niveau et de lestage.

 Estructura en acero de alta resistencia para uso a baja temperaturas • Zincado en caliente de la torre y flecha según normativa ISO 1461 • Baja emisión acústica y nivel de potencia sonora garantizada y certificada • Posibilidad de trabajar con flecha inclinada con carga variable y carro desplazable a lo largo de toda la flecha • Climatización termostática del equipamiento eléctrico para bajas y altas temperaturas • Dispositivos de autonivelamiento y auto cargado del lastre.

- Conforme alle direttive CEE: 89/392; 91/368; 93/44; 93/68 e 98/37 direttiva macchine
- Conforme alle direttive CEE: 2000/14 e 87/405 livello acustico
- Conforme alle direttive CEE: 89/336 compatibilità magnetica
- Conforme alle direttive CEE: 73/23 bassa tensione
- Conforme al D.P.R. 27/4/55 n. 547
- Le nostre macchine sono protette da assicurazione per responsabilità civile prodotti senza termine
- Specifiche suscettibili di variazioni senza preavviso.

-  • In compliance with the EEC 89/392; 91/368; 93/44; 93/68 and 98/37 regulations
- In compliance with the EEC 2000/14 and 87/405 regulations on noise levels
 - In compliance with the EEC 89/336 regulations on electromagnetic compatibility
 - In compliance with the EEC 73/23 regulations on electrical equipment
 - Machine covered by lifetime public liability insurance coverage
 - Specifications subject to modification without notice.

-  • Gemäss EWG Richtlinien 89/392; 91/368; 93/44; 93/68 und 98/37
- Gemäss EWG Richtlinien 2000/14 und 87/405 über schall-leistungspegel
 - Gemäss EWG Richtlinie 89/336 über Elektromagnetische Verträglichkeit
 - Gemäss EWG Richtlinie 73/23 über Elektrische Ausrüstung
 - Maschine unter Produkt-Haftpflichtversicherungsschutz ohne Fristangabe
 - Obiges kann ohne Berstaendigung geaendert werden.

-  • Conforme à les directives CEE 89/392; 91/368; 93/44; 93/68 et 98/37
- Conforme à les directives CEE 2000/14 et 87/405 sur le niveau acoustique
 - Conforme à la directive CEE 89/336 sur la compatibilité électromagnétique
 - Conforme à la directive CEE 73/23 sur l'équipement électrique
 - Machines assurées pour la responsabilité civile des produit sans échéance
 - Specifications susceptibles de modification sans avis préalable.

-  • Conforme con las directivas CEE 89/392; 91/368; 93/44; 93/68 y 98/37
- Conforme con las directivas CEE 2000/14 y 87/405 sobre el nivel acustico
 - Conforme con la directiva CEE 89/336 sobre la compatibilidad magnetica
 - Conforme con la directiva CEE 73/23 sobre baja tension
 - Máquina protegida y asegurada por la responsabilidad civil de productos todo riesgo
 - Especificaciones sujetas a modificaciones sin previo aviso.



SAN MARCO
INTERNATIONAL
COSTRUZIONI GRU - BETONIERE
E ATTREZZATURE EDILI

SAN MARCO INTERNATIONAL s.r.l.
via Principe Umberto, 42/B - 28021 Borgomanero (No) Italy
tel. +39 0322 82601 (4 linee r.a.) - fax +39 0322 846035
www.sanmarco-int.com sanmarco@sanmarco-int.com

Timbro rivenditore