





SMH 184

Triverter 444

-  Gru automatica idraulica
-  Automatic hydraulic crane
-  Automatischer hydraulischer kran
-  Grúa automática hidráulica
-  Grue automatique hydraulique

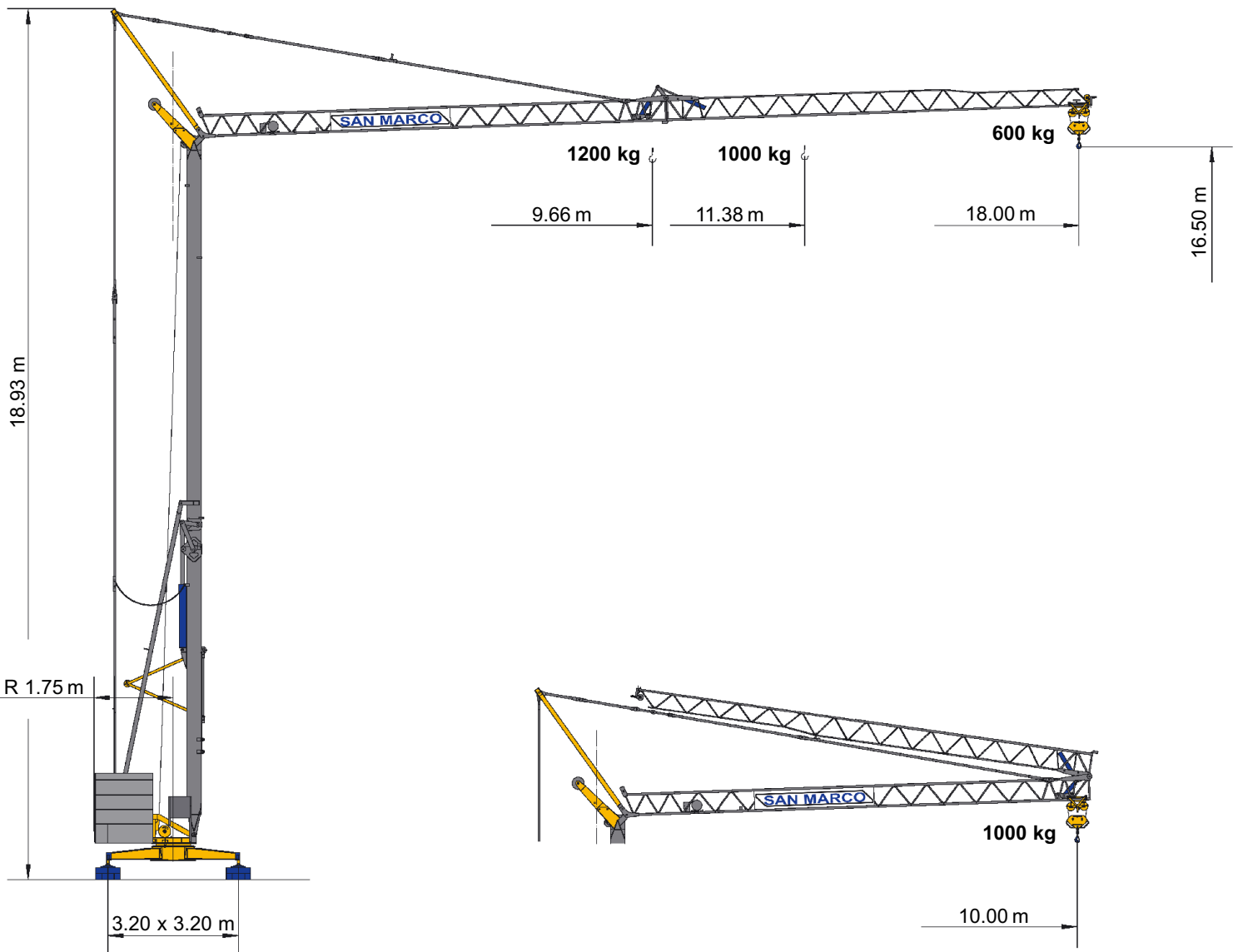
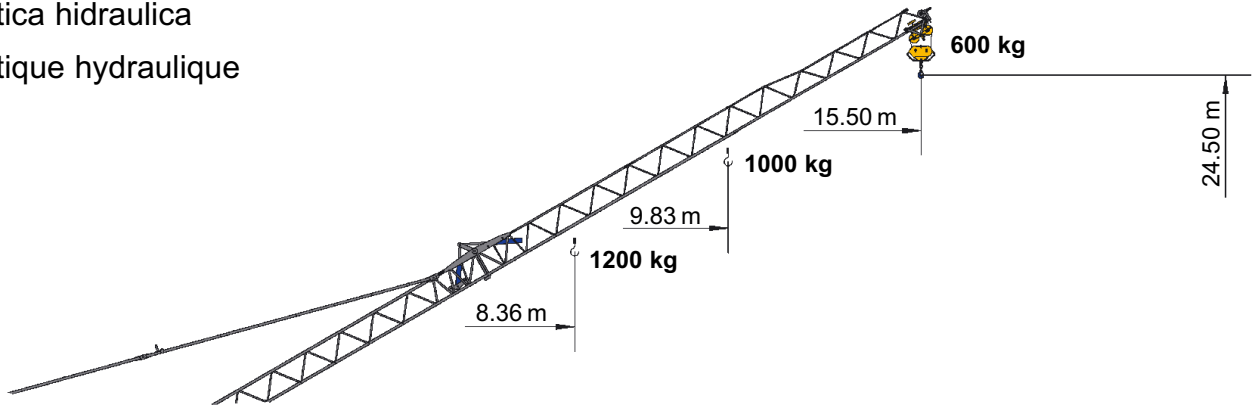

Gru automatica idraulica

Automatic hydraulic crane

Automatischer hydraulischer kran

Grua automatica hidraulica

Grue automatique hydraulique

 Montaggio

 Erection

 Montage

 Montaje

 Montage

	T	M
kW	1.5	1.8

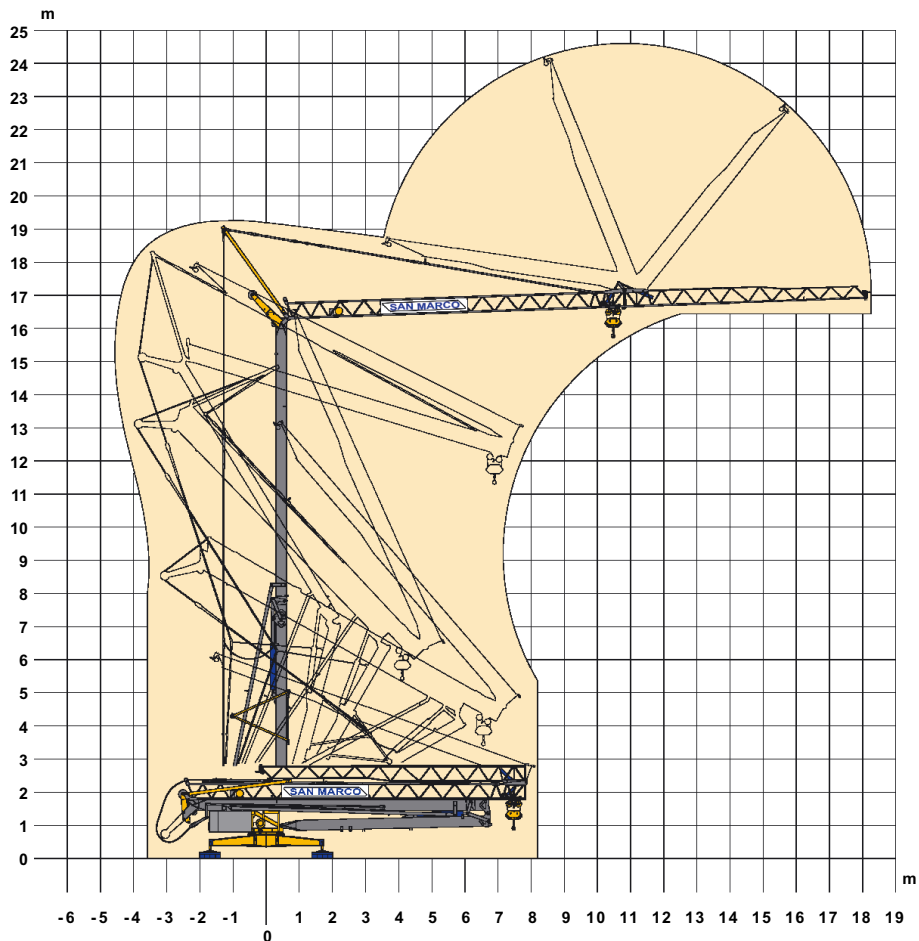



Freccia chiusa
Closed jib
Auslegerspitze zu
Flecha plegada
Flèche fermée



Kg	
1000	10.00 m

 Diagrammi di carico

 Loads diagrams

 Lastkurven

 Curvas de carga

 Courbes de charges

Braccio impennato
Inclined jib
Schräggestellter ausleger
Flecha inclinada
Flèche relevée

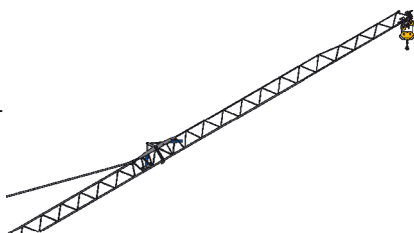

Carrello traslante
Traversing trolley
Verfahrbare laufkatze
Carro distribuidor
Chariot distributeur

Kg	18
1200	8.36 m
1100	9.03 m
1000	9.83 m
900	10.80 m
800	12.00 m
700	13.51 m
600	15.50 m





Braccio orizzontale
Horizontal jib
Waagerechter ausleger
Flecha horizontal
Flèche horizontale



Kg	18
1200	9.66 m
1100	10.44 m
1000	11.38 m
900	12.50 m
800	13.90 m
700	15.70 m
600	18.00 m

SMH 184

Triverter 444

-  Reazioni (F) - Pesì (P)
-  Reactions (F) - Loads (P)
-  Eckdrücke (F) - Krangewicht (P)
-  Reacciones (F) - Pesos (P)
-  Réactions (F) - Poids (P)

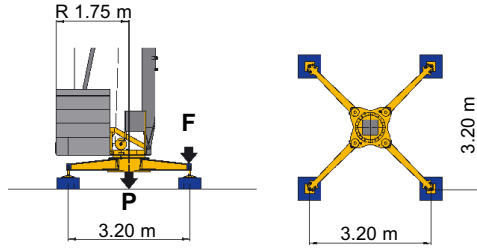





F	P
7.1 t	13.6 t

In servizio - In service - In betrieb - En servicio - En service

F	P
4.2 t	12.3 t

Fuori servizio - Out of service - Ausser betrieb - Fuera de servicio - Hors service





-  Alimentazione elettrica e potenza elettrica necessaria
-  Mains supply and power requirement
-  Netzstrom und anschlusswert
-  Alimentación eléctrica y potencia eléctrica necesaria
-  Réseau électrique et puissance électrique nécessaire

Variatore (Inverter)
Speed controller
Unrichter
Variador
Variateur

Senza variatore (Inverter) *
Without speed controller *
Ohne unrichter *
Sin variador *
Sans variateur *

	T	M
V	380 (±5%)	220 (±5%)
Hz	50	50
kW	5	3-6

	T *	M *
V	380 (±5%)	220 (±5%)
Hz	50	50
kW	5	3-6

-  Carrello
-  Trolley
-  Katzfahren
-  Carro
-  Chariot

Variatore (Inverter)
Speed controller
Unrichter
Variador
Variateur

m/min	7	14	21	28
kW	0.75			

Senza variatore (Inverter) *
Without speed controller *
Ohne unrichter *
Sin variador *
Sans variateur *

	T *	M *
m/min	28	
kW	0.75	





-  Sollevamento
-  Hoisting
-  Heben
-  Elevación
-  Levage

Variatore (Inverter)
Speed controller
Unrichter
Variador
Variateur

	T				M			
m/min	6.5	13	18.5	26	6.5	13	18.5	22
kg	1200	1200	800	600	1200	1200	800	600
kW	4				4			

Senza variatore (Inverter) *
Without speed controller *
Ohne unrichter *
Sin variador *
Sans variateur *

	T *			M *	
m/min	6	12	24	11	22
kg	1200	1200	600	1000	500
kW	1.5	2.2	3.0	1.7	1.7

-  Rotazione - Variatore (Inverter)
-  Slewing - Speed controller
-  Schwenken - Unrichter
-  Orientación - Variador
-  Orientation - Variateur

rpm	0.25	0.5	0.75	0.9
kW	1.1			

* A richiesta
On request
Auf Wunsch
Sobre demanda
Sur demande

M Monofase
Single-phase
Einphasig
Monofasica
Monophase

T Trifase
3phase
Dreiphasig
Trifasica
Triphase



Media/grande velocità carrello
Medium/major trolley speed
Mittel/große Katzgeschwindigkeit
Velocidad media/gran velocidad carro
Moyenne/grande vitesse chariot



Lontano sbraccio (sx) - vicino sbraccio (dx)
Distant jib (sx) - near jib (dx)
Ausladung fern (sx) - ausladung nah (dx)
Carro punta (sx) - carro torre (dx)
Flèche lointain (sx) - flèche proche (dx)



Rotazione sinistra (sx) - rotazione destra (dx)
Left rotation (sx) - right rotation (dx)
Drehung links (sx) - drehung rechts (dx)
Giro izquierda (sx) - giro derecha (dx)
Orientation gauche (sx) - orientation droite (dx)



Salita sollevamento (sx) - discesa sollevamento (dx)
Load block up (sx) - load block down (dx)
Heben hebevorgang (sx) - senken hebevorgang (dx)
Subida de gancho (sx) - bajada de gancho (dx)
Montée levage (sx) - descente levage (dx)







Media/grande velocità rotazione
Medium/major rotation speed
Mittel/große drehgeschwindigkeit
Velocidad media/gran velocidad giro
Moyenne/grande vitesse orientation







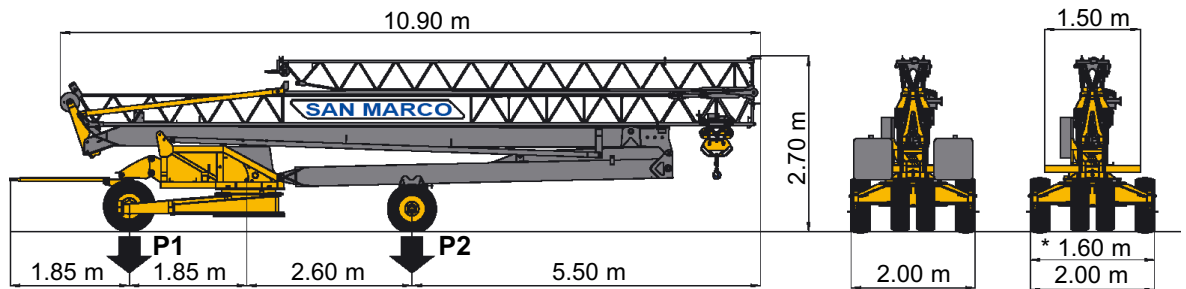

Media/grande velocità sollevamento
Medium/major hoisting speed
Mittel/große hubgeschwindigkeit
Velocidad media/gran velocidad elevacion
Moyenne/grande vitesse orientation

P1 980 kg	P2 3970 kg
P1 + P2 4950 kg	

Con assali senza zavorra di montaggio
With axles without ballast
Mit transportachse ohne montiert Ballast
Con ejes sin contrapeso de montaje
Avec essieux sans lest de montage

-  Trasporto
-  Transportation
-  Transport
-  Transporte
-  Transport



-  Assali sterzanti - spostamento laterale (a richiesta) *
-  Steering axles - lateral displacement (on request) *
-  Steuerbare achsen - seitenzustellung (auf wunsch) *
-  Eje direccional - desplazamiento lateral (sobre demanda) *
-  Essieux pivotants - déplacement lateral (sur demande) *



* A richiesta
On request
Auf Wunsch
Sobre demanda
Sur demande

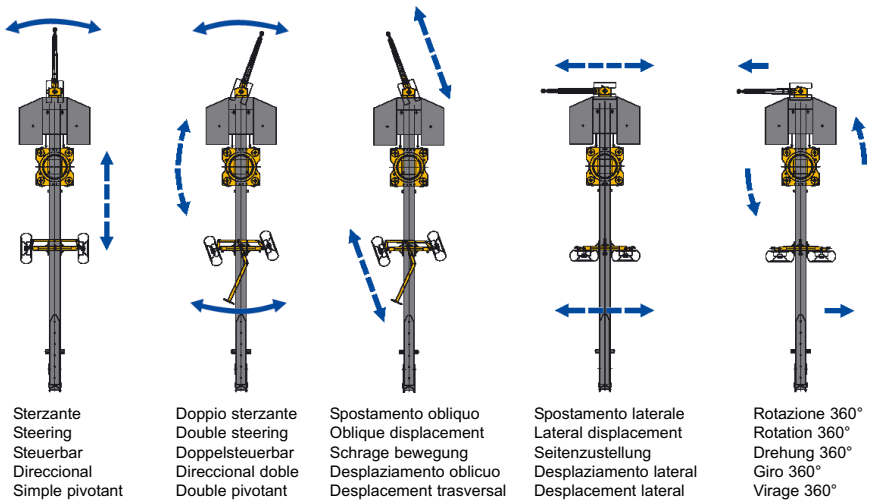

Strutture in acciaio ad alta resistenza per impiego a basse temperature • Zincatura torre e braccio con immersione a caldo secondo ISO 1461 • Bassa emissione acustica e livello di potenza sonora garantito e certificato • Possibilità di funzionamento a braccio impennato e carrello traslante • Climatizzazione termostatica dell'equipaggiamento elettrico per alte e basse temperature • Dispositivi di autolivellamento e autozavorrimento

High resilience steel structures to be used at low temperature • Galvanised tower and jib with hot dipping in conformity ISO 1461 • Guaranteed and certified low acoustics emission and sound powers level • Possibility to work with inclined jib and traversing trolley • Automatic temperature control of electrical equipment for high and low temperatures • Full automatic devices for self levelling and ballast loader.

Strukturen aus besonders schlagfesten Stahl für den Einsatz bei niedrigen Temperaturen • Turm und Ausleger lt. ISO 1461 heißverzinkt • Niedriger Geräuschpegel und Schalleistungsniveau garantiert und zertifiziert • Möglichkeit mit schräggestellten Ausleger und Laufkatze bei Abwinkelung zu arbeiten • Thermostatgesteuerte Klimatisierung der elektrischen Ausrüstung für hohe und niedrige Temperaturen • Vorrichtungen zur Selbstnivellierung und Selbstballastierung.

Estructura en acero de alta resistencia para uso a bajas temperaturas • Zincado en caliente de la torre y flecha según normativa ISO 1461 • Baja emisión acústica y nivel de potencia sonora garantizada y certificada • Posibilidad de trabajar con flecha inclinada con carro desplazable a lo largo de toda la flecha • Climatización termostática del equipamiento eléctrico para bajas y altas temperaturas • Dispositivos de autonivelamiento y auto cargado del lastre.

Charpente en acier à haute résilience pour utilisation en température ambiante froide • Galvanisation à chaud mat et flèche par immersion selon ISO 1461 • Émission acoustique réduite et niveau de puissance sonore garantie avec certificat • Possibilité de travailler avec flèche relevée et chariot distributeur • Climatisation thermostatique de l'équipement électrique pour températures ambiante élevées ou basses • Dispositifs automatiques de mise à niveau et de lestage.

 Conforme alle direttive CEE: 89/392; 91/368; 93/44; 93/68 e 98/37 direttiva macchine • Conforme alle direttive CEE: 2000/14 e 87/405 livello acustico • Conforme alle direttive CEE: 89/336 compatibilità magnetica • Conforme alle direttive CEE: 73/23 bassa tensione • Conforme al D.P.R. 27/4/55 n. 547 • Le nostre macchine sono protette da assicurazione per responsabilità civile prodotti senza termine • Specifiche suscettibili di variazioni senza preavviso.

 In compliance with the EEC 89/392; 91/368; 93/44; 93/68 and 98/37 regulations • In compliance with the EEC 2000/14 and 87/405 regulations on noise levels • In compliance with the EEC 89/336 regulations on electromagnetic compatibility • In compliance with the EEC 73/23 regulations on electrical equipment • Machine covered by lifetime public liability insurance coverage • Specifications subject to modification without notice.

 Gemäss EWG Richtlinien 89/392; 91/368; 93/44; 93/68 und 98/37 • Gemäss EWG Richtlinien 2000/14 und 87/405 über schall-Leistungspegel • Gemäss EWG Richtlinie 89/336 über Elektromagnetische Verträglichkeit • Gemäss EWG Richtlinie 73/23 über Elektrische Ausrüstung • Maschine unter Produkt-Haftpflichtversicherungsschutz ohne Fristangabe • Obiges kann ohne Berstaendigung geaendert werden.

 Conforme con las directivas CEE 89/392; 91/368; 93/44; 93/68 y 98/37 • Conforme con las directivas CEE 2000/14 y 87/405 sobre el nivel acustico • Conforme con la directiva CEE 89/336 sobre la compatibilidad magnetica • Conforme con la directiva CEE 73/23 sobre baja tension • Máquina protegida y asegurada por la responsabilidad civil de productos todo riesgo • Especificaciones sujetas a modificaciones sin previo aviso.

 Conforme à les directives CEE 89/392; 91/368; 93/44; 93/68 et 98/37 • Conforme à les directives CEE 2000/14 et 87/405 sur le niveau acoustique • Conforme à la directive CEE 89/336 sur la compatibilité électromagnétique • Conforme à la directive CEE 73/23 sur l'équipement électrique • Machines assurées pour la responsabilité civile des produit sans échéance • Specifications susceptibles de modification sans avis préalable.

Timbro rivenditore • Reseller stamp • Einzelhändlerstempel • Estampilla del minorista • Timbre de détaillant