

Gru a torre montaggio modulare SMT 40

Triverter 444

- 🇬🇧 Tower crane modular assembly
- 🇩🇪 Turmdrehkran modulare montage
- 🇫🇷 Grue a tour montage modulaire
- 🇪🇸 Grua torre montaje modular

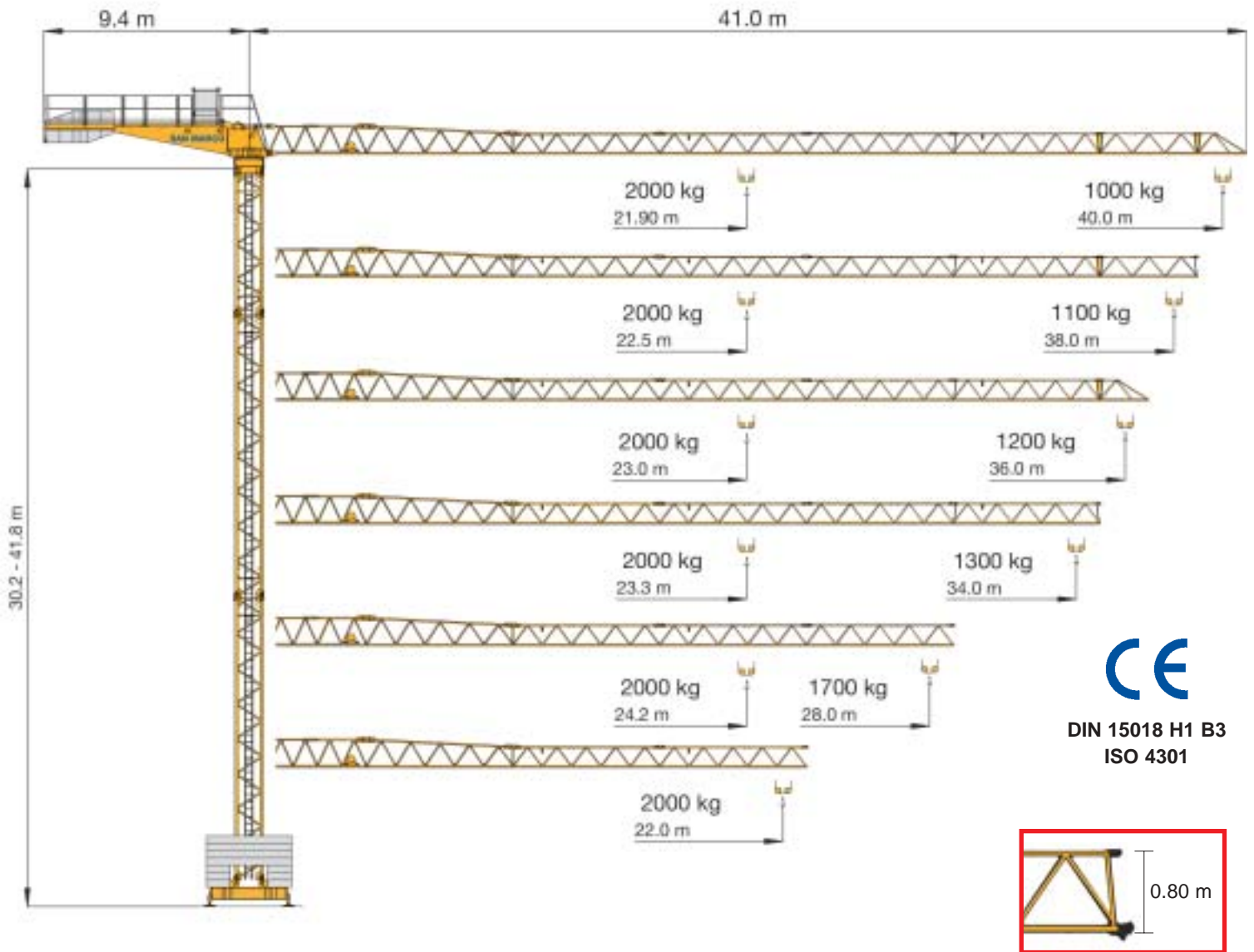

Diagrammi di carico

- Loads diagrams
- Lastkurven
- Courbes de charges
- Curvas de carga

m	12	18	20	22	24	26	28	30	32	34	36	38	40	m
	2.00	2.00	2.00	1.99	1.80	1.65	1.51	1.40	1.30	1.21	1.13	1.06	1.00	40
	2.00	2.00	2.00	2.00	1.86	1.70	1.56	1.44	1.34	1.25	1.17	1.10	38	
t	2.00	2.00	2.00	2.00	1.83	1.68	1.55	1.43	1.33	1.24	1.20	36		
	2.00	2.00	2.00	2.00	1.93	1.76	1.62	1.50	1.39	1.30	34			
	2.00	2.00	2.00	2.00	2.00	1.84	1.70	28						
	2.00	2.00	2.00	2.00	22									

2.5 t *

Tiro in II
Single wiring
Zwei Hubseilen
Simple mouflage
Tiro simple



Carrello - Variatore (Inverter)

- Trolley - Speed controller
- Katzfahren - Unrichter
- Chariot - Variateur
- Carro - Variador



		ACVF1.8			
m/min		10	20	30	40
kW		1.8			

Zavorre di volata

- Jib ballast
- Ausleger-gegengewicht
- Contrepois de la flèche
- Contrapeso de la controflecha



40 m	9.7 t
38 m	8.9 t
36 m	8.9 t
34 m	8.0 t
28 m	7.1 t

Zavorre di base NB

- Base ballast
- Basisballast
- Lest de base
- Contrapeso de la base



Carro Truck Wagen Embase Carro	Altezza Height Höhe Hauteur Altura	Zavorra Ballast Ballast Lest Contrapeso
m	m	t
3.8x3.8	12-18-24	24.0
3.8x3.8	30	30.0
3.8x3.8	36	36.0
3.8x3.8	42	48.0
3.2x3.2	12-18-24	27.6
3.2x3.2	30	32.2
3.2x3.2	36	41.4
2.8x2.8	12-18-24	32.2
2.8x2.8	30	36.8
2.8x2.8	36	46.0

Rotazione - Variatore (Inverter)

- Slewing - Speed controller
- Schwenken - Unrichter
- Orientation - Variateur
- Orientación - Variador

rpm		0.1	0.3	0.5	0.8
kW		2.5			
kgm		6.5			



Dimensioni in lunghezza e larghezza del plinto di base NB

- Sizes in length and width of the base footing
- Längenabmessungen und breite des Basisplinth
- Dimensions en longueur et largeur fondation
- Dimensiones de la zapata de base

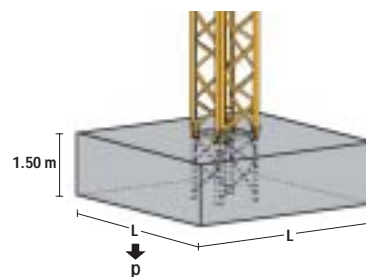

p	h = 12-18	h = 24	h = 30	h = 36	h = 42
	L x L				
daN/cm ²	m	m	m	m	m
1.0	4.1x4.1	4.1x4.1	4.3x4.3	4.9x4.9	5.5x5.5
1.2	3.7x3.7	3.7x3.7	4.1x4.1	4.6x4.6	5.2x5.2
1.4	3.5x3.5	3.5x3.5	3.8x3.8	4.3x4.3	4.9x4.9
1.6	3.3x3.3	3.3x3.3	3.6x3.6	4.1x4.1	4.6x4.6
1.8	3.1x3.1	3.1x3.1	3.4x3.4	3.9x3.9	4.4x4.4
2.0	3.0x3.0	3.0x3.0	3.3x3.3	3.8x3.8	4.3x4.3

Sblocco freno di rotazione

- Rotation brake release
- Drehungsbremseentblockung
- Ouverture du frein d'orientation
- Desbloqueo freno de giro



Intervento manuale
Manual intervention
Hand-Antrieb
Commande manuelle
Intervencion manual



Intervento con radiocomando o pulsantiera
Intervention with radioremoté/
cable radio control
Antrieb mit Funksteuerung oder Steuerpulte
Commande à distance par radio ou par cable
Intervencion con mando a distancia
o botonera

Gru a torre montaggio modulare SMT 40

Triverter 444

Composizione torre

- Tower composition
- Turmzusammenstellung
- Composition mât
- Composicion de torre

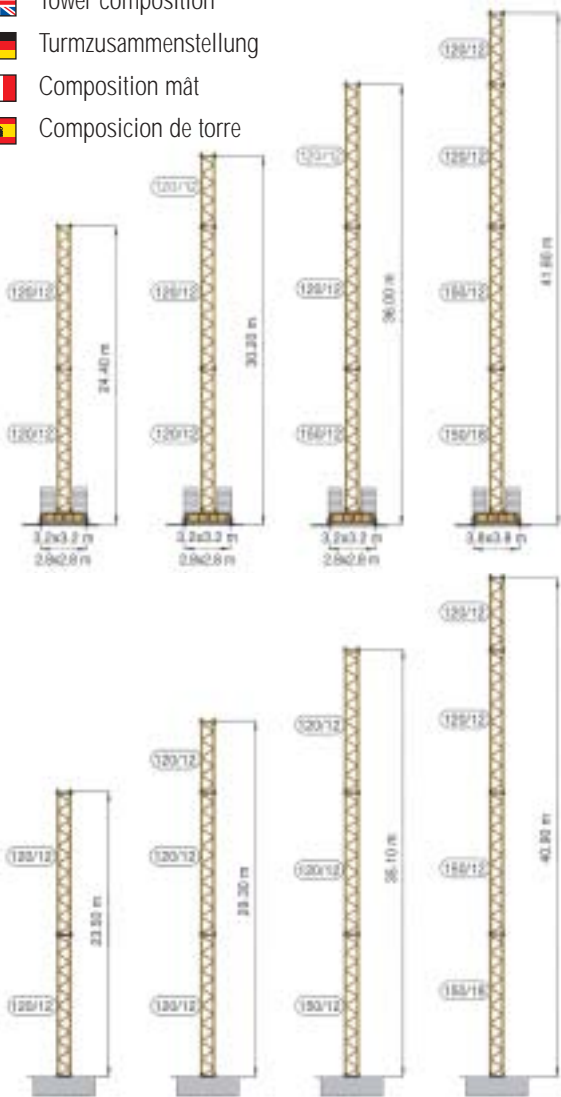

Torre altezza 70 m

- Tower height 70 m
- Turm Höhe 70 Meter
- Hauteur du mât 70 metres
- Altura de torre 70 metros

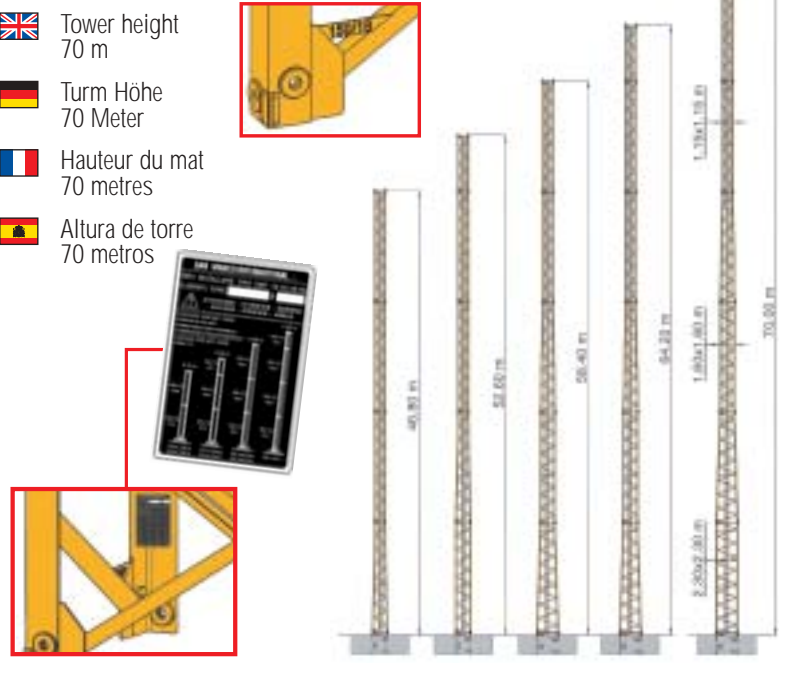

Anemometro

- Anemometer
- Windmesser
- Anemometre
- Anemometro



Potenza elettrica necessaria

- Power requirement
- Anschlusswert
- Puissance électrique nécessaire
- Potencia eléctrica necesaria

V	380
Hz	50
kW	25

Sollevamento - Variatore (Inverter)

- Hoisting - Speed controller
- Heben - Unrichter
- Levage - Variateur
- Elevación - Variador

	ASVF11				ASVF15*			
m/min	10	30	45	60	10	30	45	60
t	2.0	2.0	1.4	0.8/1.0	2.5	2.5	1.8	1.2
kW	11				15			

Altezza Height Höhe Hauteur Altura	Carro Truck Wagen Embase Carro	In servizio In use In Betrieb En service En servicio	Fuori servizio Out of order Ausser Betrieb Hors service Fuera servicio
m	m	t	t
12-18-24	3.8x3.8	22.0	16.0
30	3.8x3.8	25.0	22.0
36	3.8x3.8	28.0	28.0
42	3.8x3.8	33.0	37.0
12-18-24	3.2x3.2	24.0	19.0
30	3.2x3.2	27.0	24.0
36	3.2x3.2	31.0	33.0
12-18-24	2.8x2.8	27.0	20.0
30	2.8x2.8	30.0	27.0
36	2.8x2.8	35.0	36.0

Azioni su stabilizzatori



- Actions on the stabilizers
- Wirkung auf die Stabilisatoren
- Action sur les verins
- Reacciones sobre estabilizadores

NB Uguali per tutte le lunghezze di braccio • Same for all jib lengths • Für alle Auslegerlängen gleich • Egal pour toutes les longueurs de fleche • Igual para todas las longitudes de flecha

* A richiesta • On request • Auf Wunsch • Sur demande • Sobre demanda

Comandi da terra

-  Ground control
-  Antriebe von Boden
-  Commande du sol
-  Maniobra desde tierra
(en el primer tramo
o base de grua)



Sezionatore linea
On/off switch
Schalter
Sectionneur de ligne
Seccionador de linea

Commutatore radiocomando/pulsantiera
Radioremoté/cable radio control selector
Umschalter Funksteuerung/Steuerpulte
Commutateur radio commande-boite à boutons
Commutador mando a distancia/botonera

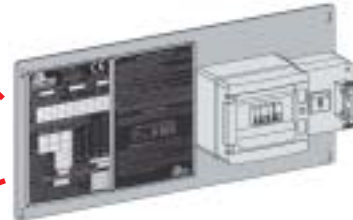
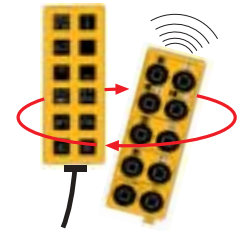



Interruttore fano
On/off light switch
Beleuchtungschalter
Interrupteur phare
Interruptor luz roja





Sblocco freno di rotazione
Rotation brake release
Drehungsbremseentblockung
Ouverture du frein d'orientation
Desbloqueo freno de giro

- Strutture in acciaio ad alta resistenza per impiego a basse temperature
- Braccio e torre a montaggio modulare
- Bassa emissione acustica e livello di potenza sonora garantito e certificato
- Climatizzazione termostatica dell'equipaggiamento elettrico per alte e basse temperature
- Mezzi di accesso alla parte superiore della gru
- Anemometro con segnalatore ottico e acustico

-  • High-strength steel structure for use at low temperatures
- Modular assembly jib and tower
- Guaranteed and certified low acoustics emission and sound powers level
- Automatic temperature control of electrical equipment for high and low temperatures
- Disassembled stair on the tower
- Anemometer with optical and acoustic indicator

-  • Strukturen aus hochfestem Stahl für den Einsatz bei niedrigen Temperaturen
- Ausleger und Turm mit modularer Montage
- Niedriger Geräuschpegel und Schallleistungspegel garantiert und zertifiziert
- Thermostatgesteuerte Klimatisierung der elektrischen Ausrüstung für hohe und niedrige Temperaturen
- Ausrüstungen für den Zugang zum oberen Teil des Krans
- Windmesser mit optischen Signalton

-  • Structures en acier à haute résistance pour utilisation aux basses températures
- Fleche et mât a montage modulaire
- Émission acoustique réduite et niveau de puissance sonore garantie avec certificat
- Climatization thermostatique de l'équipement électrique pour températures ambiante élevées ou basses
- Escaliers d'accès au mat démontables
- Anémomètre avec avertisseur optique et acoustique

-  • Estructura en acero de alta resistencia para trabajar a baja temperaturas
- Flecha y torre de montaje modular
- Baja emisión acústica y nivel de potencia sonora garantizada y certificada
- Climatización termostática del equipamiento eléctrico para bajas y altas temperaturas
- Medios de acceso a la parte superior de la grúa
- Anemometro con señalizador optico y acustico

- Conforme alle direttive CEE: 89/392; 91/368; 93/44; 93/68 e 98/37 direttiva macchine
- Conforme alle direttive CEE: 2000/14 e 87/405 livello acustico
- Conforme alle direttive CEE: 89/336 compatibilità magnetica
- Conforme alle direttive CEE: 73/23 bassa tensione
- Conforme al D.P.R. 27/4/55 n. 547
- Le nostre macchine sono protette da assicurazione per responsabilità civile prodotti senza termine
- Specifiche suscettibili di variazioni senza preavviso.

-  • In compliance with the EEC 89/392; 91/368; 93/44; 93/68 and 98/37 regulations
- In compliance with the EEC 2000/14 and 87/405 regulations on noise levels
- In compliance with the EEC 89/336 regulations on electromagnetic compatibility
- In compliance with the EEC 73/23 regulations on electrical equipment
- Machine covered by lifetime public liability insurance coverage
- Specifications subject to modification without notice.

-  • Gemäss EWG Richtlinien 89/392; 91/368; 93/44; 93/68 und 98/37
- Gemäss EWG Richtlinien 2000/14 und 87/405 über schall-leistungspegel
- Gemäss EWG Richtlinie 89/336 über Elektromagnetische Verträglichkeit
- Gemäss EWG Richtlinie 73/23 über Elektrische Ausrüstung
- Maschine unter Produkt-Haftpflichtversicherungsschutz ohne Fristangabe
- Obiges kann ohne Berstaendigung geändert werden.

-  • Conforme à les directives CEE 89/392; 91/368; 93/44; 93/68 et 98/37
- Conforme à les directives CEE 2000/14 et 87/405 sur le niveau acoustique
- Conforme à la directive CEE 89/336 sur la compatibilité électromagnétique
- Conforme à la directive CEE 73/23 sur l'équipement électrique
- Machines assurées pour la responsabilité civile des produit sans échéance
- Specifications susceptibles de modification sans avis préalable.

-  • Conforme con las directivas CEE 89/392; 91/368; 93/44; 93/68 y 98/37
- Conforme con las directivas CEE 2000/14 y 87/405 sobre el nivel acustico
- Conforme con la directiva CEE 89/336 sobre la compatibilidad magnetica
- Conforme con la directiva CEE 73/23 sobre baja tension
- Máquina protegida y asegurada por la responsabilidad civil de productos todo riesgo
- Especificaciones sujetas a modificaciones sin previo aviso.



SAN MARCO
INTERNATIONAL
COSTRUZIONI GRU - BETONIERE
E ATTREZZATURE EDILI

SAN MARCO INTERNATIONAL s.r.l.
via Principe Umberto, 42/B - 28021 Borgomanero (No) Italy
tel. +39 0322 82601 (4 linee r.a.) - fax +39 0322 846035
www.sanmarco-int.com sanmarco@sanmarco-int.com

Timbro rivenditore